New as of:

03.2019



Orthophos S 2D, Orthophos S 2D Ceph Orthophos S 3D, Orthophos S 3D Ceph

Firmware V05.14 / PC-Software V1.4

Operating Instruction

English

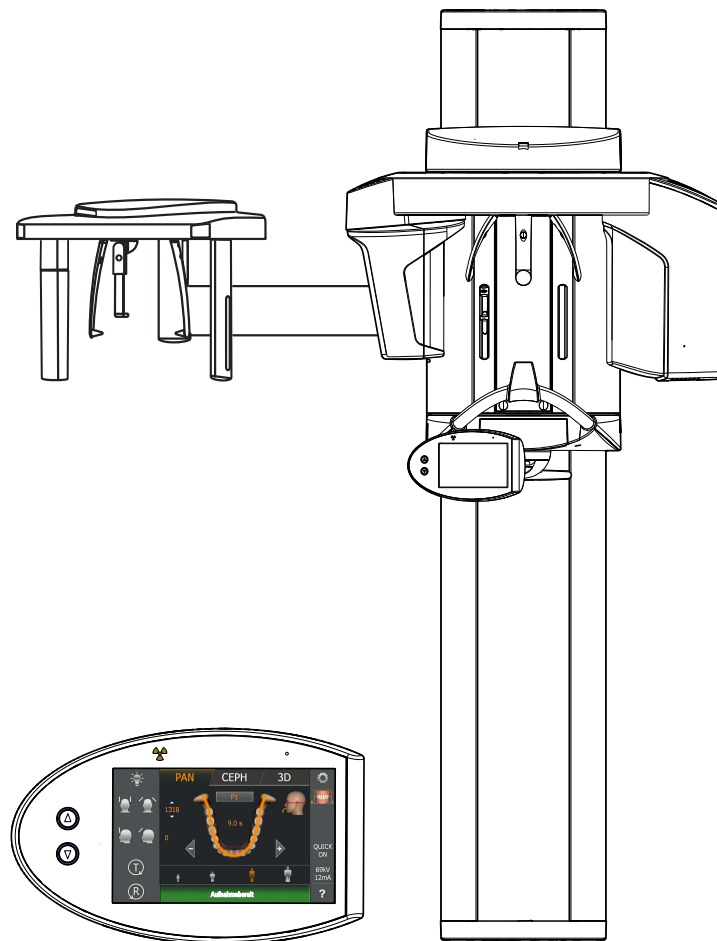

Table of contents

1	General data	6
1.1	Dear Customer,.....	6
1.2	Contact information	6
1.3	Copyright and trademark	7
1.4	General information on the operating Instructions	7
1.4.1	Structure of the document.....	8
1.4.1.1	Identification of the danger levels	8
1.4.1.2	Formats and symbols used	8
1.5	Other relevant documents.....	9
1.6	Warranty and liability.....	9
1.7	Obligation of system owner and personnel.....	9
1.8	Intended use	10
1.9	Indication and contraindication	10
2	Safety instructions	11
2.1	Basic safety information	11
2.2	Notes on the unit.....	11
2.3	Ventilation slots.....	11
2.4	Condensation	12
2.5	Qualifications of operating personnel.....	12
2.6	Switch on the unit.....	12
2.7	Radiation protection	12
2.8	Emergency Stop	13
2.9	Laser light localizer	13
2.10	Hygiene.....	13
2.11	Touchscreen	13
2.12	Trouble-free operation	14
2.13	Interference with electronic devices.....	14
2.14	Risks of electromagnetic fields	14
2.15	Combination with other equipment	14
2.16	Changes to the unit.....	15
2.17	Structural alterations	15
2.18	Electromagnetic compatibility	15
2.19	Electrostatic discharge.....	16

3	Unit description	18
3.1	Certification and registration	18
3.2	Technical data.....	19
3.2.1	Unit data.....	19
3.2.2	Transport, storage, and operating conditions	21
3.2.3	Diagrams.....	22
3.2.4	Values of the secondary scattered radiation.....	23
3.2.5	Requirements on the PC systems	24
3.3	Overview of exposure programs	25
3.4	Main components of the product.....	28
3.4.1	Basic unit	28
3.4.2	Cephalometer	29
3.4.3	Easypad	30
3.4.4	Easypad touchscreen	31
3.4.5	Remote control.....	35
3.5	Spare parts and consumables	36
3.5.1	Accessory parts	36
3.5.1.1	Bite blocks and contact segments.....	36
3.5.1.2	3D bite block and spherical bite blocks	37
3.5.1.3	Universal and occlusal bite block	37
3.5.1.4	Temple supports, forehead support, and temporomandibular joint supports	38
3.5.2	Hygienic protective sleeves	39
3.5.2.1	Protective sleeves for the basic unit.....	39
3.5.2.2	Protective sleeves for cephalometer	40
3.5.3	Test phantom for acceptance/constancy test	41
4	Installation and start-up	42
4.1	Replacing accessories on the basic unit.....	42
4.1.1	Replacing the bite block, contact segment, 3D bite block or chin rest.....	42
4.1.2	Using the occlusal bite block.....	42
4.1.3	Using the universal bite block	44
4.1.4	Using spherical bite blocks and the spherical bite block plate	45
4.1.5	Changing the temple supports and temporomandibular joint supports	45
4.2	Adjusting/inserting accessory parts on the cephalometer.....	46
4.3	Removing/inserting the Ceph sensor.....	47

5	Operation	48
5.1	Acquiring the X-ray image.....	48
5.1.1	Switching the unit on and starting the software	48
5.1.1.1	Switching the unit on	48
5.1.1.2	Enabling exposure readiness in Sidexis 4.....	49
5.1.2	Selecting an exposure program.....	51
5.1.2.1	Panoramic and bite wing exposure	51
5.1.2.2	Temporomandibular joint exposure.....	68
5.1.2.3	Sinus view	75
5.1.2.4	Volume exposures.....	83
5.1.2.5	Cephalometric exposures.....	101
5.1.2.6	Pediatric exposures	114
5.1.3	Releasing the exposure	116
5.1.3.1	Starting the test cycle	116
5.1.3.2	Releasing the exposure.....	116
5.1.3.3	Rescue program for image transfer problems.....	120
5.1.3.4	Using the remote control	124
5.1.3.5	Canceling an exposure.....	125
5.2	Preselecting basic settings	126
5.2.1	Changing the basic settings and start settings	126
5.2.1.1	PAN program group.....	126
5.2.1.2	3D program group	128
5.2.1.3	CEPH program group.....	129
5.2.2	Adjusting the touchscreen.....	131
5.2.3	Calling the info screen	132
5.2.4	Calling the service menu.....	133
6	Service.....	134
6.1	Cleaning and care.....	134
6.1.1	Cleaning.....	134
6.1.2	Disinfecting	134
6.1.3	Sterilization	136
6.1.4	Cleaning the occlusal bite block.....	137
6.2	Inspection and maintenance	138

7	Malfunctions.....	140
7.1	Help messages	140
7.2	Error message structure	142
7.3	Error description.....	143
7.3.1	Ex – Error type	143
7.3.2	yy – Locality	145
8	Settings and repair.....	146
8.1	Program values.....	146
8.1.1	Panoramic exposure index 1E.....	146
8.1.2	Panoramic exposure index 2E.....	148
8.1.3	Panoramic exposure index 3E.....	150
8.1.4	Volume exposure.....	152
8.1.4.1	Effective dosing by region, volume area on the object/ field of view and setting	155
8.1.5	Cephalometric exposures	158
8.1.6	Dose information.....	159
8.1.6.1	Dose area product parameters for Panorama images .	159
8.1.6.2	Dose area product parameters for Ceph-images	163
8.1.6.3	Calculate dosage.....	164
9	Dismantling and disposal.....	166
9.1	Dismantling and reinstallation	166
9.2	Disposal	166

1 General data

1.1 Dear Customer,

We are pleased that you have equipped your practice with the Orthophos S X-ray system from Dentsply Sirona.

Dentsply Sirona was one of the first inventors of film-based panoramic X-ray systems and since 1996 has been a pioneer of digital X-ray technology. You benefit from the vast experience we have gained through the thousands of digital panoramic X-ray systems installed worldwide. This device is characterized by many features including outstanding image quality, simple operation, and a high day-to-day reliability.

This operating manual should be of good help to you before use as well as serve anytime later as a reference material.

We wish you every success with using your Orthophos S system.

Your Orthophos S team,

1.2 Contact information

Customer Service Center

In the event of technical queries, please use our online contact form at the following address:

<http://srvcontact.sirona.com>

Manufacturer's address



Sirona Dental Systems GmbH
Fabrikstrasse 31
64625 Bensheim
Germany

Tel.: +49 (0) 6251/16-0

Fax: +49 (0) 6251/16-2591

e-Mail: contact@dentsplysirona.com

www.dentsplysirona.com

1.3 Copyright and trademark

Copyright

© Sirona Dental Systems GmbH. All rights reserved.

The information contained in this manual may be changed without notice.

The software and all related documentation are protected by copyright. You must therefore handle it in the same way as any other protected material.

Anyone who copies this software to any medium for any purpose other than his own personal use without the written permission of Sirona Dental Systems will be liable to prosecution.

Trademarks

Microsoft[®], Windows 7[®], and Windows 10[®] are registered trademarks.

Windows[™] is a trademark of Microsoft Corporation.

All other trademarks are the property of their respective holders.

Notes on 3rd party code libraries must be stored in license.pdf in the installation directory.

1.4 General information on the operating Instructions

Observe the Operating Instructions

Please familiarize yourself with the unit by reading through these Operating Instructions before putting it into operation. It is essential that you comply with the specified warning and safety information.

Tip: A quick guide containing brief operating instructions has been provided to help you look up functions quickly.

Always keep the Operating Instructions handy in case you or another user require(s) information at a later point in time. Save the Operating Instructions on the PC or print them out.

If you sell the unit, make sure that the Operating Instructions are included with it either as a hard copy or on an electronic storage device so that the new owner can familiarize himself with its functions and the specified warning and safety information.

Online portal for technical documents

We have set up an online portal for the Technical Documents at www.dentsplysirona.com/manuals. From here, you can download these Operating Instructions along with other documents. Please complete the online form if you would like a hard copy of a particular document. We will then be happy to send you a printed copy free of charge.

Help

If you continue to have difficulties despite having thoroughly studied the Operating Instructions, please contact your dental depot.

1.4.1 Structure of the document

1.4.1.1 Identification of the danger levels

To prevent personal injury and material damage, please observe the warning and safety information provided in these operating instructions. Such information is highlighted as follows:

 **DANGER**
 An imminent danger that could result in serious bodily injury or death.

 **WARNING**
 A possibly dangerous situation that could result in serious bodily injury or death.

 **CAUTION**
 A possibly dangerous situation that could result in slight bodily injury.

NOTE
 A possibly harmful situation which could lead to damage of the product or an object in its environment.

IMPORTANT
 Application instructions and other important information.

Tip: Information for simplifying work.

1.4.1.2 Formats and symbols used

The formats and symbols used in this document have the following meaning:

<ul style="list-style-type: none"> ✓ Prerequisite 1. First action step 2. Second action step or > Alternative action ↪ Result > Individual action step 	Requests you to do something.
See "Formats and symbols used [→ 8]"	Identifies a reference to another text passage and specifies its page number.
• List	Designates a list.
"Command / menu item"	Indicates commands / menu items or quotations.

1.5 Other relevant documents

The X-ray system includes other components, such as PC software, which are detailed in separate documents. Instructions and warning and safety information provided in the following documents must be taken into account:

- SIDEXIS 4 User Manual

1.6 Warranty and liability

Maintenance

In the interest of the safety and health of patients, users and other persons, inspection and preventive maintenance must be performed at scheduled intervals to ensure the operational reliability and functional safety of your product (IEC 60601-1 / DIN EN 60601-1 etc.).

The system owner is responsible for making sure that all scheduled inspections and preventive maintenance activities are performed.

As manufacturers of medical electrical equipment we can assume responsibility for the safety-related features of the equipment only if maintenance and repair are carried out only by ourselves or agencies expressly authorized by us, and if components affecting safe operation of the system are replaced with original spare parts upon failure.

Exclusion of liability

In the event that the system owner fails to fulfill the obligation to perform scheduled inspections and preventive maintenance activities or ignores error messages, Sirona Dental Systems GmbH and its authorized dealers cannot assume any liability for damages.

Certificate of work

We suggest that you request a certificate, showing the nature and extent of the work performed, from those who carry out such work, and specify that the certificate show any changes in rated parameters or working ranges, as well as the date, the name of the firm and a signature.

1.7 Obligation of system owner and personnel

These operating instructions presuppose that you are familiar with the use of Sidexis software.

Prior to the exposure, please ask women of a childbearing age as to whether they are pregnant or not. If the patient is pregnant, a risk/benefit analysis must be performed.

According to the X-ray Ordinance of Germany, owners of X-ray equipment must perform constancy tests at regular intervals in order to ensure the safety of operating staff and patients. Dentsply Sirona recommends monthly testing.

1.8 Intended use

The X-ray system creates data for digital exposures in the maxillofacial area and in subareas for dentistry and pediatric dentistry, for hard-tissue diagnostics within ENT medicine, and carpus exposures.

The Operating and Maintenance Instructions must be observed.

WARNING

3D X-rays may not be used for routine or medical check-ups for which an X-ray exposure is produced irrespective of the existence or non-existence of clinical signs and symptoms. 3D X-ray examinations must be able to be justified for each patient in order to demonstrate that the benefits outweigh the risks.

1.9 Indication and contraindication

Indications in dentistry areas:

- Conservative dentistry
- Endodontics
- Periodontology
- Prosthodontics / template scan exposures
- Functional diagnosis and therapy of craniomandibular dysfunctions
- Surgical dentistry
- Implantology
- Oral and maxillofacial surgery
- Orthodontics
- Pediatric dentistry
- ENT medicine (hard-tissue diagnostics)

Contraindications:

- Display of cartilage structures
- Display of soft tissue

2 Safety instructions

2.1 Basic safety information

NOTE

This unit must not be operated in areas subject to explosion hazards.

2.2 Notes on the unit

The following symbols are applied to the unit:

This symbol can be found next to the rating plate on the unit.

Meaning: Observe the Operating Instructions when operating the unit.



This symbol can be found on the rating plate on the unit.

Meaning: The accompanying documents are available on the Dentsply Sirona homepage.



Electrostatic discharge (ESD)

Connector pins or sockets bearing ESD warning labels must not be touched or interconnected without ESD protective measures. See also 'Electrostatic discharge' and 'Electromagnetic compatibility'.



Identification of single use devices

Prior to each exposure, the hygienic protective sleeves (single use devices) must be fitted.

Single use devices are identified with the symbol shown on the left.

They must be disposed of immediately after use. Do not use single use devices more than once.



2.3 Ventilation slots

Under no circumstances may the ventilation slots on the unit be covered, since otherwise the air circulation will be obstructed. This can cause the unit to overheat.

Do not spray liquids such as disinfectants into the ventilation slots. This may lead to malfunctions. Use wipe disinfection only in the vicinity of the ventilation slots.

Do not spray into the ventilation slots



2.4 Condensation

Extreme temperature fluctuations may cause condensation inside the unit. Do not switch the unit on before it has reached normal room temperature. See also the chapter Technical data [→ 19].

2.5 Qualifications of operating personnel

The unit may only be operated by skilled or properly trained personnel.

Personnel, who are to be trained, taught, instructed or are taking part in a general training, may operate the device only under the supervision of an experienced person.

To operate the unit, the operating personnel must:

- have read and understood the Operating Instructions
- be familiar with the fundamental structure and functions of the unit
- be able to recognize irregularities in the functioning of the unit and implement the appropriate measures where necessary

The operators of the unit must be adequately trained in the DVT technology with regard to the principles of operation and radiation protection.

2.6 Switch on the unit

The patient may not be positioned in the unit when starting it and setting the operating mode (until the sensor has been positioned). Malfunction may cause injury to the patient.

In case of an error that requires switching the unit off and back on again, the patient must be removed from the unit, at the latest before the unit is switched back on.

2.7 Radiation protection

The valid radiation protection regulations and measures must be observed. The statutory radiation protection equipment must be used. In order to reduce radiation exposure, Dentsply Sirona recommends using bismuth or lead shields or aprons, especially for pediatric patients.

During an exposure, the operator should move as far away from the X-ray tube assembly as the coiled cable of the release button permits.

With the exception of the patient, no other persons without radiation protection are allowed to stay in the room during an exposure. In exceptional cases, a third person may provide assistance, but not the practice staff. Visual contact with the patient and the unit must be maintained throughout the entire exposure.

In case of malfunctions, cancel the exposure immediately by letting go of the exposure release button.

2.8 Emergency Stop

If any parts of the unit touch the patient during the rotary movement, let go of the exposure release button (X-Ray) immediately or stop the unit at once by actuating the unit main switch or an Emergency Stop switch (not included in the scope of supply)!

2.9 Laser light localizer

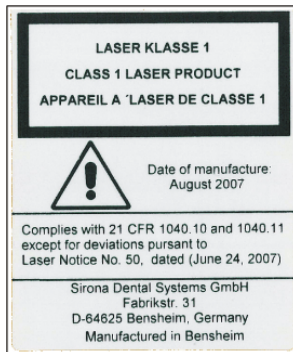

The system incorporates Class 1 laser products.

The light localizers are intended for correct patient positioning. They must not be used for any other purposes.

A minimum distance of 10 cm (4") is required between the eye and the laser. Do not stare directly into the laser beam.

Make sure that the laser beam does not meet the eyes of the patient. Prior to activating the light localizers, the patient must be asked to shut their eyes.

The light localizers may be switched on only when functioning perfectly. Repair work must be carried out by authorized staff only.

Do not use the system with any other lasers, and do not make any changes to settings or processes that are not described in these operating instructions. This may lead to a dangerous exposure to radiation.

2.10 Hygiene

The protective sleeves must be reapplied for each patient, all auxiliary exposure tools must also be disinfected to avoid potential transmission of pathogens that may cause serious illnesses.

Application components without disposable protective covers must be disinfected prior to patient positioning in order to prevent cross-contamination.

Suitable hygienic measures must be taken to prevent cross contamination between patients, users, and other persons.

The following chapters contain more information about sterilization and hygienic protective sleeves: "Hygienic protective sleeves [→ 39]", "Preparing the exposure", "Sterilization [→ 136]".

2.11 Touchscreen

The EasyPad monitor is equipped with touch-sensitive control technology.

The touchscreen must not be operated with pointed objects such as ball-point pens, pencils, etc. Such objects could damage or scratch its surface. Always operate the touchscreen by pressing it gently with your fingertip.

2.12 Trouble-free operation

Use of this system is permissible only if it works properly without malfunctions. If trouble-free operation cannot be ensured, the unit must be taken out of service, checked by authorized technicians for malfunctions and, if necessary, repaired.

X-rays of patients may be taken only when the system is working trouble-free.

The movements of the unit must not be obstructed by physical constitution, clothing, dressings, wheelchairs, or hospital beds.

The travel range of the unit must be kept free from foreign matter.

Do not leave the patient at the unit unattended.

The device may only be operated with a complete cover and protective hood.

2.13 Interference with electronic devices

To prevent the malfunctioning of electronic devices and data memories, these objects must be removed prior to the X-ray exposure.

2.14 Risks of electromagnetic fields

The function of implanted systems (cardiac pacemakers or cochlear implants, for example) can be affected by electromagnetic fields. Before commencing treatment, ask if the patient has a cardiac pacemaker or any other implanted system.

Any prevailing risks are listed in the documentation provided by the implant manufacturer.

2.15 Combination with other equipment

Putting together or altering a medical electrical system by combining with other devices in accordance with IEC 60601-1 (safety requirements for medical electrical systems) is subject to the obligation to ensure compliance with the requirements of this provision for patient safety, the operator, and the environment.

If any devices not approved by Dentsply Sirona are connected, they must comply with the applicable standards:

- IEC 60950-1 or IEC 62368-1 for information technology equipment and
- IEC 60601-1 for medical electrical equipment

To this end, refer to the 'Installation requirements' and compatibility list/declaration of conformity by the system integrator.

If in doubt, contact the manufacturer of the system components.

2.16 Changes to the unit

Modifications to this unit which might affect the safety of the system owner, patients, or other persons are prohibited by law!

For reasons of product safety, this product may be operated only with original Dentsply Sirona accessories or third-party accessories expressly approved by Dentsply Sirona. The user is responsible for any damage resulting from the use of non-approved accessories.

2.17 Structural alterations

If structural changes are made in the vicinity of the X-ray unit which result in the device being exposed to very high levels of vibration or even impact, the device must be inspected by a service engineer and re-adjusted and re-calibrated if necessary.

2.18 Electromagnetic compatibility

The acquisition unit complies with the requirements of the standard IEC 60601-1-2.

Medical electrical devices are subject to special precautionary measures with regard to electromagnetic compatibility (EMC). It must be installed and operated as specified in the "Installation Requirements" document.

Portable and mobile RF communications equipment may affect medical electrical equipment.

If the installation requirements and the following recommendations are not observed, there is a risk that the X-ray images will not have the correct exposure.

The correctness of the radiation parameters and the repeatability of the dose values in particular may be affected.

In the case of repairs, only use replacement parts approved by Dentsply Sirona.

Only use disinfectants approved by Dentsply Sirona so as not to damage electrical insulation.

Portable HF equipment must not be placed within a 30 cm radius of the X-ray unit.

HF surgery units and X-ray units must not be operated at the same time.

2.19 Electrostatic discharge

Protective measures

ESD stands for **E**lectro**S**tatic **D**ischarge.

Electrostatic discharge from people can damage electronic components when the components are touched. Damaged components usually have to be replaced. Repairs must be performed by qualified personnel.

Measures to protect against ESD include:

- Procedures to avoid electrostatic charging via
 - air conditioning
 - air humidification
 - conductive floor coverings
 - non-synthetic clothing
- discharging the electrostatic charges from your own body through contact with
 - a metallic unit casing
 - a larger metallic object
 - any other metal part grounded with the protective earth
- Wearing an antistatic band that creates a connection between the body and a protective ground wire.

Areas at risk are indicated on the unit with the ESD warning label:

We recommend that all persons working with this system are made aware of the significance of the ESD warning label. A training course should also be held to inform users about the physics of electrostatic charges.

Physics of electrostatic charges

An electrostatic discharge requires prior electrostatic charging.

There is a danger of electrostatic charges building up whenever two bodies rub against each other, e.g. when:

- walking (soles of shoes against the floor) or
- moving (chair casters against floor).

The amount of charge depends on several factors. The charge is:

- higher at low air humidity than at high air humidity, and
- higher with synthetic materials than with natural materials (clothing, floor coverings).

The following rule of thumb can be applied to assess the transient voltages resulting from an electrostatic discharge.

An electrostatic discharge is:

- perceptible at 3,000 V or higher
- audible at 5,000 V or higher (cracking, crackling)
- visible at 10,000 V or higher (arc-over)

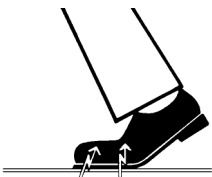
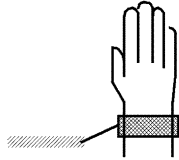
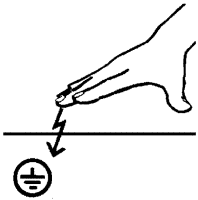

The transient currents resulting from these discharges have a magnitude of over 10 amps. They are not hazardous for humans because they last for only several nanoseconds.

Note: nanosecond = 1/1,000,000,000 second = 1 billionth of a second

Voltage differentials exceeding 30,000 volts per centimeter may lead to a charge transfer (electrostatic discharge, lightning, spark-over).

Integrated circuits (logical circuits and microprocessors) are used in order to implement a wide variety of functions in a device. The circuits must be miniaturized to a very high degree in order to include as many functions as possible on these chips. This leads to structure thicknesses as low as a few ten thousandths of a millimeter. Integrated circuits that are connected to wires leading externally are therefore particularly at risk from electrostatic discharge.

Even voltages that are imperceptible to the user can cause breakdown of the structures, thus leading to a discharge current that melts the chip in the affected areas. Damage to individual integrated circuits may cause malfunction or failure of the unit.

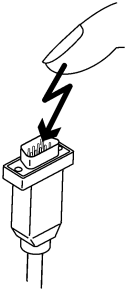

3 Unit description

3.1 Certification and registration

The Orthophos S X-ray unit complies with IEC 60601-1:2005 + A1:2012

The Orthophos S X-ray unit complies with IEC 60601-1-3:2008 + A1:2013

The Orthophos S X-ray unit complies with IEC 60601-2-63:2012

Original language: German

This product bears the CE marking in accordance with the provisions of Council Directive 93/42/EEC of June 14, 1993 concerning medical devices.



3.2 Technical data

3.2.1 Unit data

Model designation:	Orthophos S
Nominal voltage:	200 – 240 V
Permissible fluctuation:	± 10%
Permissible drop under load:	10%
Rated current:	12 A
Nominal power output:	2 kW at 90 kV/12 mA with any radiation time
Nominal frequency:	50 Hz / 60 Hz
Mains resistance:	max. 0.8 ohms
Main building fuse:	25 A slow-blow (16 A for single line)
Power consumption:	2 kVA
Power output of tube assembly:	69 kV / 16 mA = 1104 W with any radiation time
Tube voltage:	60 – 90 kV (for 90 kV max. 12 mA)
Tube current:	3 – 16 mA (for 16 mA max. 69 kV)
Maximum setting range:	60 kV / 3 mA to 90 kV / 12 mA
High-voltage waveform:	High-frequency multipulse Residual ripple ≤ 4 kV
High voltage generation frequency:	40 – 120 kHz
Program duration:	See "Program values" [-> 146]
Exposure time:	See "Program values" [-> 146]
Image acquisition scale:	For P1, normal dental arch (slice center) approx. 1:1.25, i.e. the acquired image is magnified by approx. 24% on average compared to reality.
Exposure time for a cephalometric image:	14.9 s max.
Image acquisition scale for a cephalometric image:	approx. 1:1.1, i.e. the acquired image is magnified by approx. 10% on average compared to reality.
Total filtration of X-ray tube assembly:	> 2.5 mm Al / 90 IEC 60522 0.3 mm Cu for volume exposures 1 mm Cu for volume exposures in Low Dose mode
Focal spot size as specified in IEC 60336, measured in the central X-ray beam:	0.5 mm

Marking of focal spot:

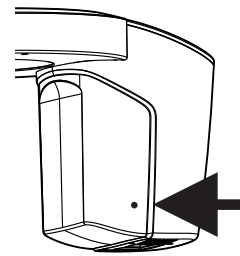

Source-skin distance

> 200 mm (8")

Automatic exposure blocking:

The duration of automatic exposure blocking (cooling period) depends on the set kV/mA level and the actual exposure time. Depending on the tube load, interval times of 8 s to 300 s are automatically set by the system.

Example: For program P1 with exposure data of 84 kV / 12 mA and a radiation time of 14.1 s, the pause duration is 150 s.

Equipment class:

IPX0

Class I device
Degree of protection
against electric shock:

Type B device

Degree of protection
against ingress of water:

Ordinary equipment (without protection
against ingress of water)

Year of manufacture:

20XX (on the rating plate)

Operating mode:

Continuous operation

Long-term power output:

200 W

Anode material:

Tungsten

Exposure parameters for
determining leakage radiation:

2 mA / 90 kV

X-ray tube

Siemens SR 90/15 FN

Panorama sensor

Digital CMOS sensor for Panorama X-ray technique

Active sensor area, Pan type:	145.152 mm x 6.48 mm
Pixel size:	0.108 mm
Focus-sensor distance:	493 mm

Flat Panel Detector

Digital Flat Panel Detector with a-Si technology (amorphous silicon)

With 3D exposure technology:

Active sensor area	160 mm x 160 mm
Pixel size:	0.12 mm
Focus-sensor distance:	524 mm
Max. filtration in front of sensor:	< 1.2 mm Al

Ceph sensor

Digital line sensor with CCD technology

Active sensor area, Ceph type:	230 mm x 6.48 mm
Pixel size:	0.027 mm
Focus-sensor distance:	1,714 mm

3.2.2 Transport, storage, and operating conditions

Orthophos S

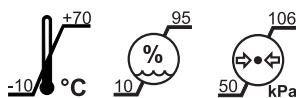

Transport and storage conditions: Temperature: -10°C – +70°C (14°F – 158°F)
Relative humidity: 10% – 95%
Air pressure: 50 kPa – 106 kPa

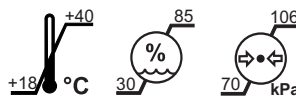

Operating conditions: Ambient temperature +18°C – +40°C (64°F – 104°F)
Relative humidity: 30% - 85% (no condensation)
Air pressure: 70 kPa – 106 kPa
Operating altitude: ≤ 3,000 m above sea level

Cephalometer

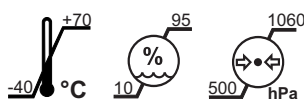

Transport and storage conditions: Temperature: -40°C – +70°C (-40°F – 158°F)
Relative humidity: 10% – 95%
Air pressure: 500 hPa – 1060 hPa

3.2.3 Diagrams

Cooling curve for tube housing

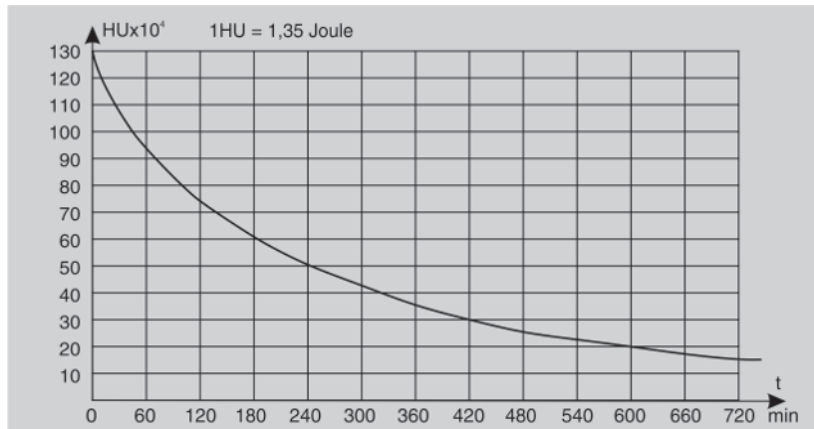

Cooling curve of X-ray tube

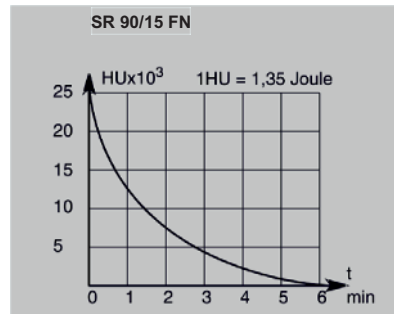

Heating curve of tube housing

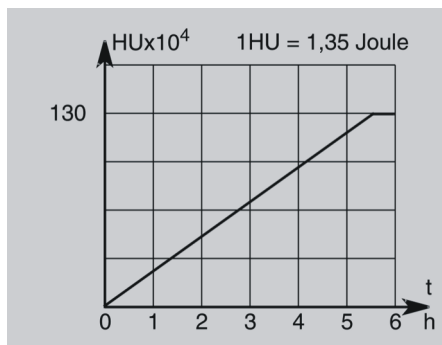

Central X-ray beam and anode angle

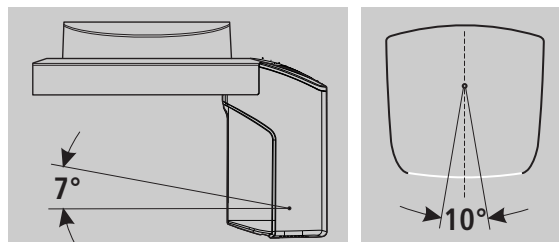

3.2.4 Values of the secondary scattered radiation

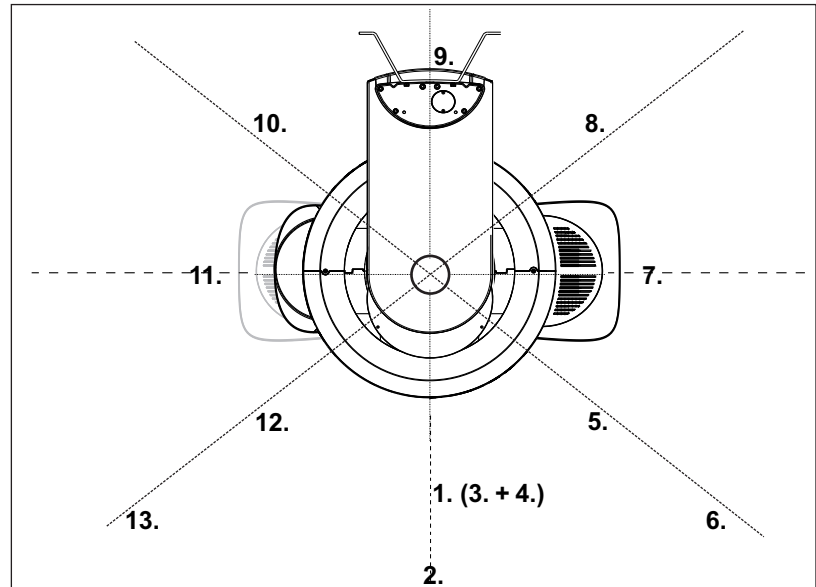

The highest scattered radiation is listed here as it is generated in the HD mode for 3D X-ray operation.

3D X-ray measurement criteria:

The following parameters were set for the measurements:
 Tube voltage 85 kV,
 tube current 7 mA,
 radiation time 14.1 s (corresponds to a current-time product of 98.7 mAs).

Angle [°]	Measuring point	Distance [m]	Measured dose [μSv]	Dose/mAs [μSv]
0	1	1	3.6	0.0365
	2	2	0.96	0.00973
	3	1 (45° below)	3.55	0.0359
	4	1 (45° above)	0.75	0.00759
45	5	1	5.59	0.0556
	6	2	1.52	0.0154
90	7	1	7.68	0.0778
135	8	1	11.10	0.112
180	9	1	0.6	0.00607
225	10	1	9.63	0.0976
270	11	1	7.04	0.0713
315	12	1	4.55	0.0461
315	13	2	1.31	0.0132

3.2.5 Requirements on the PC systems

The requirements on the PC systems can be found in the installation requirements

Sidexis 4 REF 66 63 236.

Orthophos S REF 64 95 183

3.3 Overview of exposure programs

The following is a list of the available exposure programs and the possible program settings. The exposure programs are displayed on the touchscreen in abbreviated form.

Panoramic exposures

Panoramic exposure program		Quadrants
P1	Panoramic exposure, standard	
P1 A	Panoramic exposure, artifact-reduced	
P1 C	Panoramic exposure, constant 1.25x magnification	
P2	Panoramic exposure, without ascending rami	
P2 A	Panoramic exposure, without ascending rami, artifact-reduced	
P2 C	Panoramic exposure, without ascending rami, constant 1.25x magnification	
P10	Panoramic exposure for children	
P10 A	Panoramic exposure for children, without ascending rami, artifact-reduced	
P10 C	Panoramic exposure for children, without ascending rami, constant 1.25x magnification	
P12	Thick slice, anterior tooth region	

Program settings:



Single-quadrant selection (only upper/ lower jaw for P12),

Quickshot function (no P12 for Quickshot function),

kV/mA values

For more information about the panoramic exposure programs, see "P1 – Panoramic exposure [-> 51]" onwards.

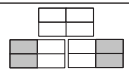
Bitewing exposures

Bitewing exposure programs		Quadrants
BW1	Bitewing exposures in the posterior tooth region	
BW2	Bitewing exposures in the anterior tooth region	

Program settings: For BW1 quadrant selection left/right half-view or both sides, kV/mA values

For more information about the bitewing exposure programs, see BW1 – Bite wing exposure in the posterior tooth region [→ 54].

Temporomandibular joint exposures

TM1.1/TM1.2	Temporomandibular joints from a lateral aspect with the mouth open and closed, two-part exposure
TM3	Temporomandibular joints lateral, ascending rami

Program settings: In two-part exposure programs with angle preselection (0°, 5°, 10°, 15°), kV/mA values

For more information about the temporomandibular joint exposure programs, see "TM1.1 / TM1.2 – Lateral view of temporomandibular joints with mouth open and closed [→ 68]" onwards.

Sinus exposures

S1	Paranasal sinuses
S3	Paranasal sinuses, linear slice orientation

Program settings: kV/mA values

For more information about the sinus exposure programs, see "S1 – Paranasal sinuses [→ 75]" onwards.

Cephalometric exposures

If the unit is equipped with a cephalometer, you can also take cephalometric images.

C1	Posterior-anterior exposure, symmetrical
C2	Anterior-posterior exposure, symmetrical
C3	Lateral exposure
C3F	Full-format exposure, lateral
C4	Carpus view, symmetrical



Program settings: Quickshot function, collimation (except for C4), kV/mA values

For more information about the cephalometric exposure programs, see "C1 – Posterior-anterior exposure, symmetrical [→ 101]" onwards.

Volume exposure

The Orthophos S X-ray system is available as a 2D or 2D/3D hybrid device. 2D devices are prepared for subsequent upgrades with a 3D flat panel detector. The volume programs VOL1 SD, VOL1 HD, VOL1 Low, VOL2 SD, VOL2 HD, VOL2 Low (VOL3 SD, VOL3 HD and VOL3 Low as an option) are only available in addition with this.

The Low Dose mode in programs VOL1, VOL2 und VOL3 is not available in every country.

Programs	Volume area	Collimation
VOL1 SD Isotropic voxel edge length: 160 µm VOL1 HD Isotropic voxel edge length: 160 µm VOL1 Low Isotropic voxel edge length: 160 µm	Volume exposure with a diameter of approx. 8 cm and a height of approx. 8 cm or 5.5 cm collimated.	
VOL2 SD Isotropic voxel edge length: 160 µm VOL2 HD Isotropic voxel edge length: 80 µm VOL2 Low Isotropic voxel edge length: 160 µm	Volume exposure with a diameter of about 5 cm and a height of about 5.5 cm for upper or lower mandible	
Optional VOL3 SD Isotropic voxel edge length: 220 µm VOL3 HD Isotropic voxel edge length: 160 µm VOL3 Low Isotropic voxel edge length: 220 µm	Volume exposure with a diameter of about 11 cm and a height of about 10 cm or selection of upper quadrant collimated to 7.5 cm and selection lower quadrant collimated to 8.0 cm	

Program settings: Volume area (anterior teeth, molars right/left or temporomandibular joints right/left), collimation of upper/lower jaw, radiation time

For more information about the 3D exposure program, see "Volume exposures [→ 83]" onwards.

3.4 Main components of the product

3.4.1 Basic unit

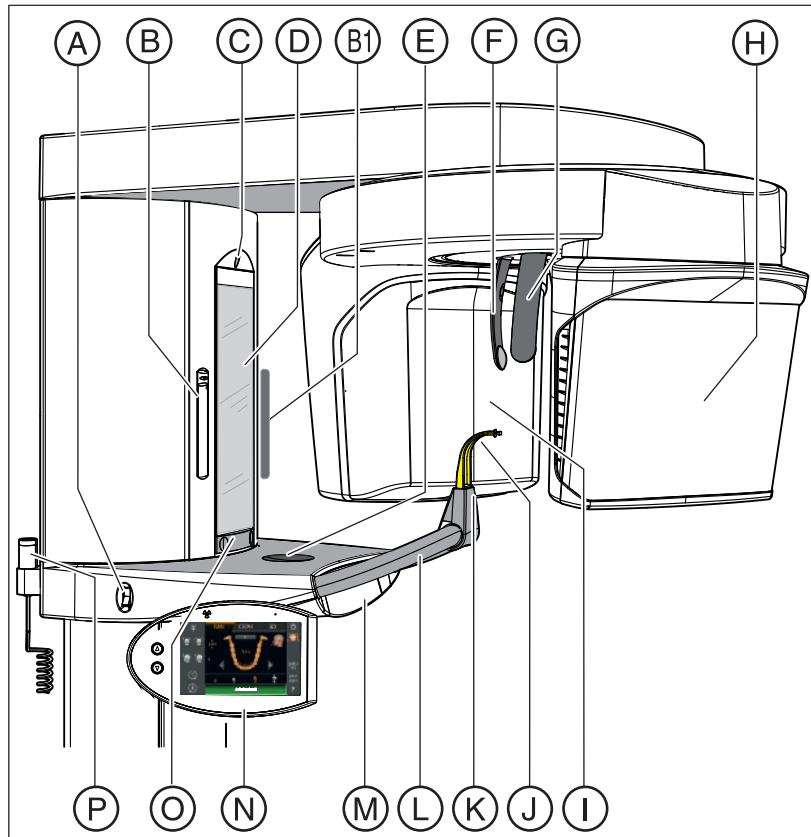

A	Main switch
B	Light localizer with height adjustment of the laser line (Frankfurt plane) for panoramic exposures
B1	Light localizers for 3D positioning
C	Light localizer central laser line for face center
D	Control mirror for patient positioning
E	Tray for jewelry, etc.
F	Forehead support
G	Temple supports
H	PAN/3D sensor unit
I	Primary diaphragm field on the X-ray tube assembly
J	Bite block, contact segment or chin rest
K	Holder for chin rest, bite blocks, or contact segments etc.
S	Handle for patient
M	Drawer for accessories
N	Easypad (swiveling and tilting operator panel)

O	Touch bar for swiveling the control mirror in and out
P	Exposure release button

3.4.2 Cephalometer

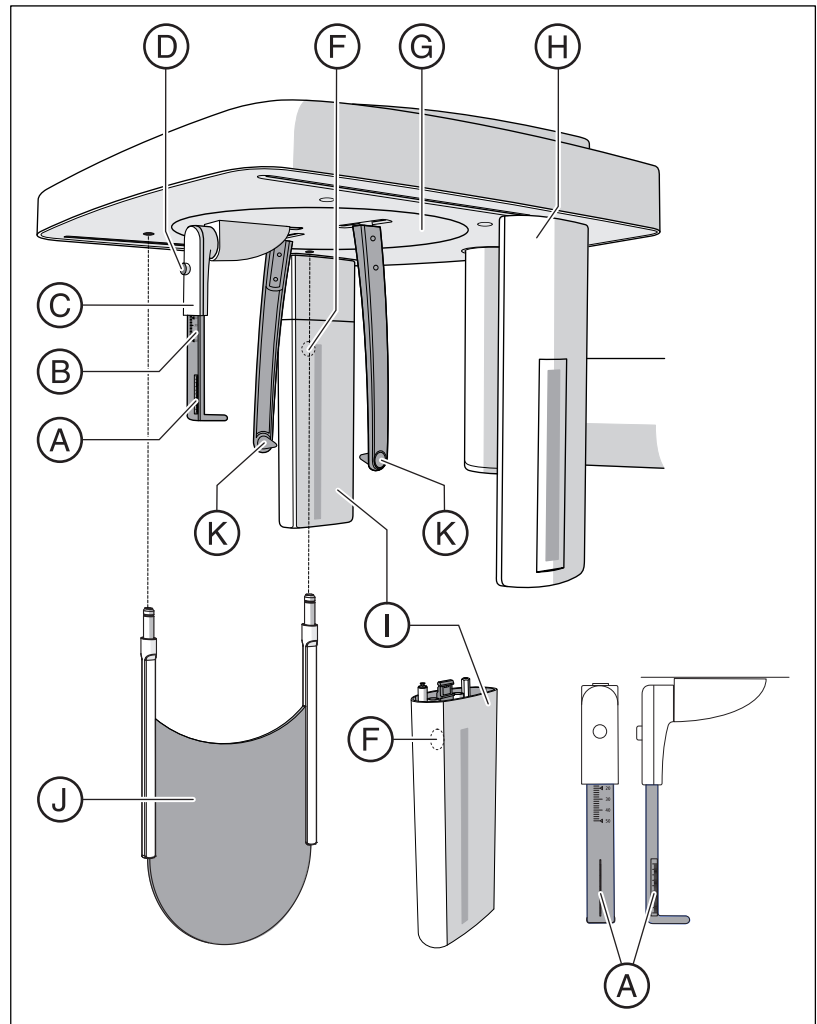

A	Projection scale
B	Scale for vertical nose support adjustment
C	Nose support
D	Locking knob for nose support
F	Pushbutton for sensor removal
G	Rotating element for rotary movement of head supports
H	Secondary diaphragm with light localizer of laser line (Frankfurt horizontal plane)
I	Sensor
J	Carpus support plate
K	Ear plugs with holders

3.4.3 Easypad

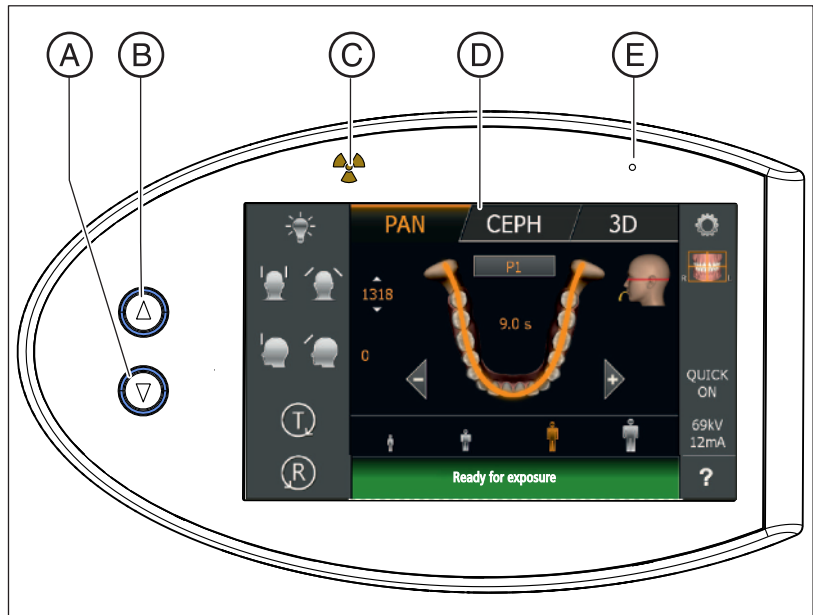

A	"Unit down" key
B	"Unit up" arrow key
C	Optical radiation indicator
D	Touchscreen (touch-sensitive screen)
E	"Unit ON" LED display

3.4.4 Easypad touchscreen

The screen for this system is a touchscreen, which responds to touch by the user. The user touches the screen surface to make the settings for X-ray exposures.

The structure of the user interface is subdivided into 2 levels. By touching the toothed wheel J in the upper right corner of the touchscreen, you can switch to the 2nd level:

Level 1: Main menu

Control and display elements

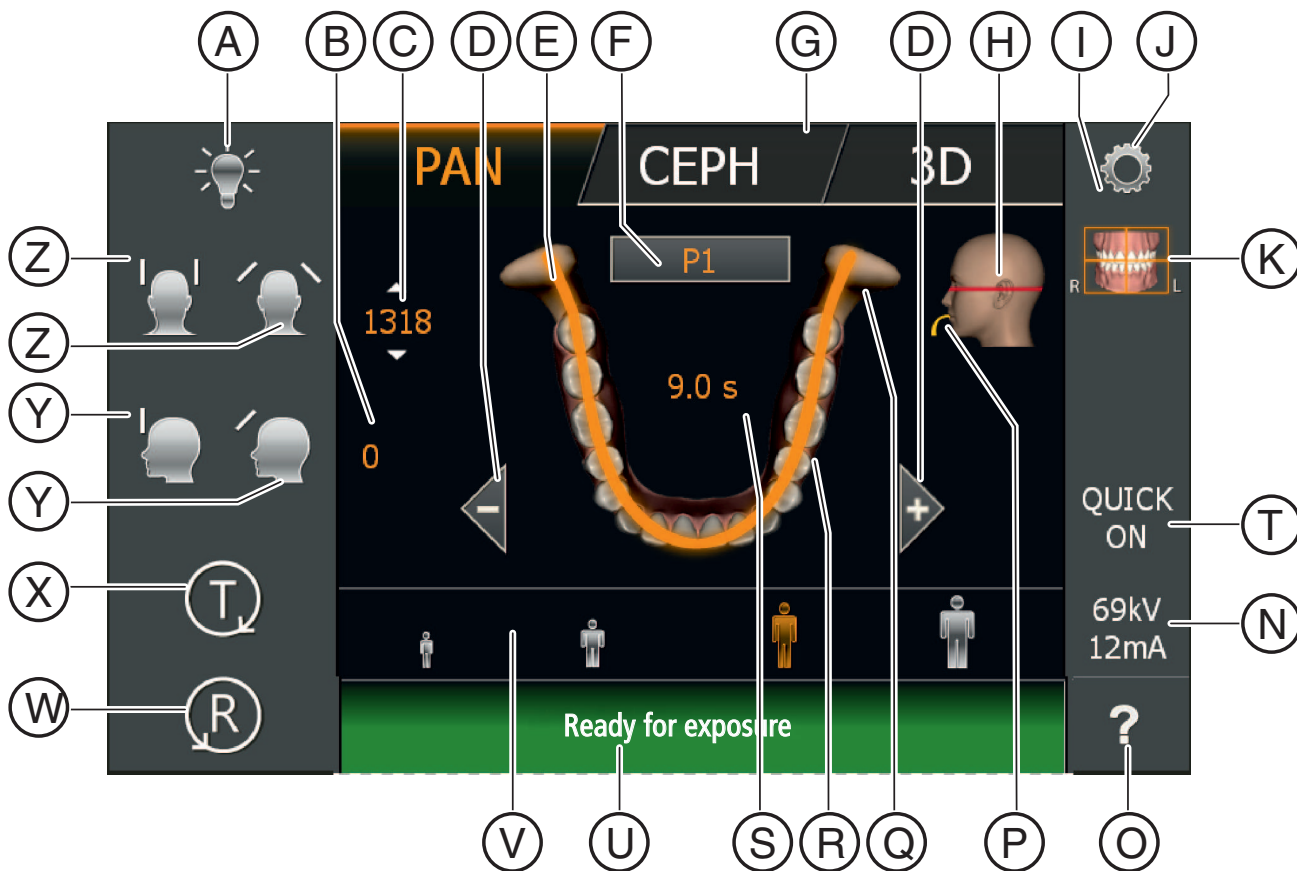

A	Light localizer ON/OFF
B	Forehead support adjustment display
C	Display of height adjustment
D	Program selection keys +/- sequence PAN: P1, P2, P10, P12, BW1, BW2, TM1.1, TM3, S1, S3 CEPH: C1, C2, C3, C4 3D: VOL1, VOL2, VOL3
E	Orange: Display of the minimum exposure area for the selected program (mandibular arch or mandibular arch segment)
F	Program display, selection of subprograms (A/C)

G	Display of program group selection
H	Display of patient head positioning
I	Submenu column (options)
J	Toothed wheel Navigation element to switch between levels 1 and 2
K	Quadrant selection display marked with R (right) and L (left)
N	Display of kV/mA value
O	Question mark: Help or info screen
P	Display of color-coded bite block or contact segment for the chosen program
Q	Symbol for temporomandibular joints
R	Symbol for mandibular arch
S	Expected radiation time (after completion: actual radiation time)
T	PAN: Quick ON / Quick OFF Reduction in the exposure/radiation time 3D: SD / HD / Low Dose Reduction in the patient dose
U	Comment line for help and error messages
V	Patient symbols (child, youth/woman, woman/man, large individuals): Exposure parameter presettings
W	"R" button for acknowledging device messages. The return of the unit is one of these messages!
X	"T" key for test cycle without radiation
Y	"Move forehead support towards forehead" and "Move forehead support away from forehead" keys
Z	"Close temple supports" and "Open temple supports" keys

Display aid for patient head positioning

The patient head symbol shown on the top right helps you to position the patient's head.

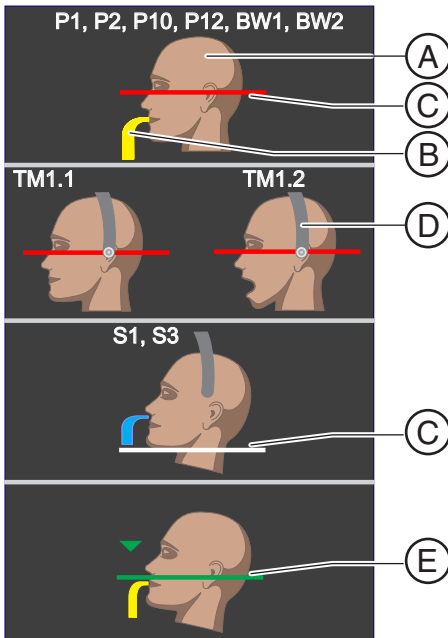

A	The patient head icon shows the head posture: straight (Frankfurt horizontal plane), bent forward (anterior) with open or closed mouth, or reclined.
B	A colored symbol (yellow or blue) indicates if a bite block or a contact segment should be used.
C	In <i>red</i> , this line shows the reflecting light localizer line (Frankfurt horizontal), in <i>white</i> it is simply used as a guide for the corresponding head inclination.
D	For temporomandibular joint and sinus views, the temporomandibular joint support is also displayed in blue. If a small circle with a dot in its center appears at the end of the support, ear holders must be inserted; only contact pads are required if this symbol is not displayed.
E	When using the occlusal bite block, a green line and a green arrow are shown for positioning.

Level 2: Sub-menus

- **Selecting the basic settings**

In the 2nd level, the factory-set exposure parameters of the programs and the adaptation of the kV/mA values stored for the patient symbols are changed.

The settings are then preselected by default every time the unit is switched on and for every new exposure.

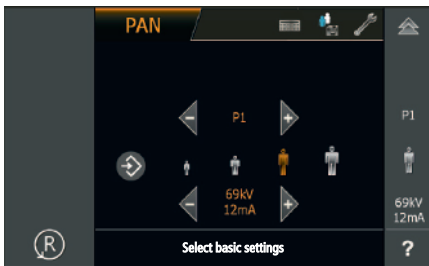

- **Selecting default settings**

You can access the start settings via the diskette symbol at the top of the touchscreen. In the default settings, the patient symbol can be preselected and the Quickshot function can be enabled/disabled.

The settings are then preselected by default every time the unit is switched on and for every new exposure.

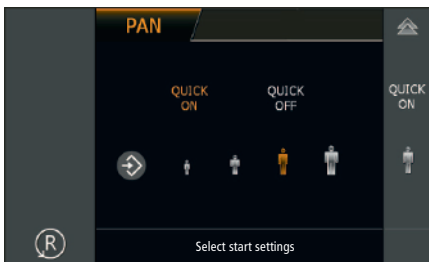

- **Selecting the service menu**

The spanner icon is used to access the service menu. The service menu is intended exclusively for service engineers. Service routines can



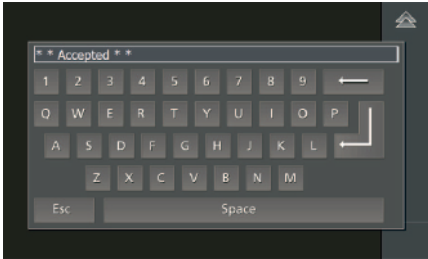

be activated and unit settings incl. tests and calibrations can be performed in this menu.

- **Activating functions**

The keyboard icon is used to access the keyboard. The service menu is intended exclusively for service engineers.

Color codes

Settings are marked with two different colors:

- **Orange:** selected
The function or value has been selected by the user.
- **White:** preset
This function or value is preset in the system. The user can change the setting by touching.

3.4.5 Remote control

⚠ CAUTION

Increased radiation

If several units are installed in the same room, the remote controls must be suitably labeled to make it clear which control is for which unit.

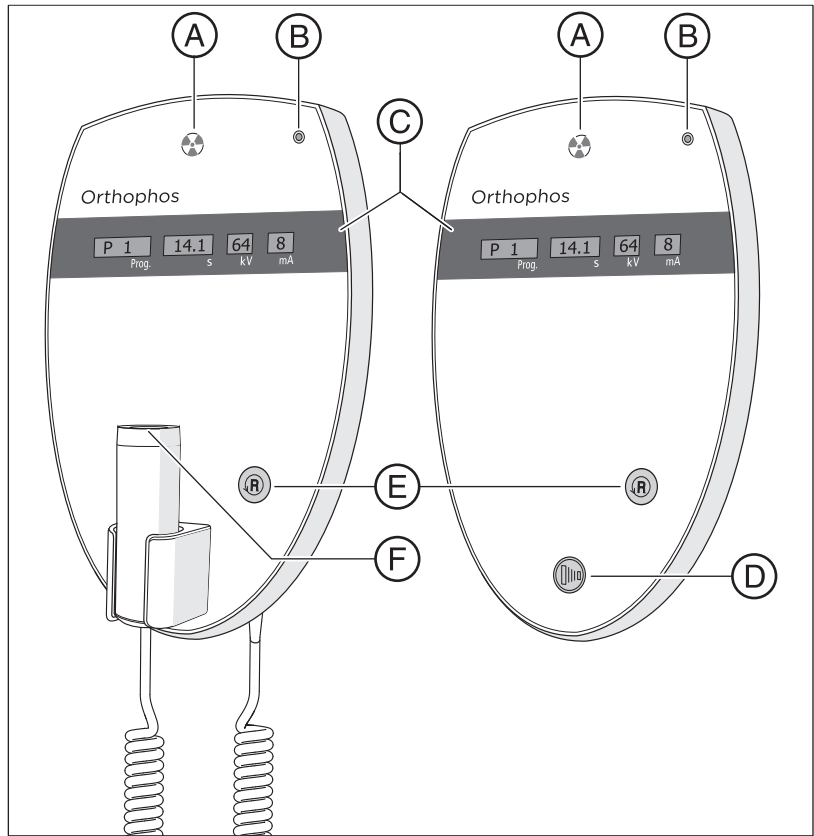

A	Radiation indicator
B	LED display "Unit ON"
C	Display field
D	Exposure release button
E	"R" button to reverse the unit
F	Exposure release button with coiled cable

3.5 Spare parts and consumables

3.5.1 Accessory parts

3.5.1.1 Bite blocks and contact segments

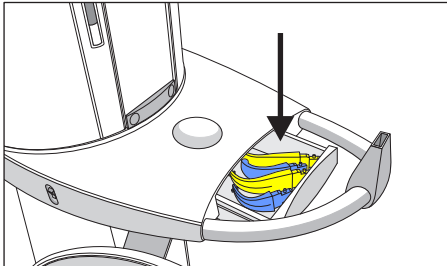

The drawer between the handles is provided for the storage of accessory parts and hygienic protective sleeves.

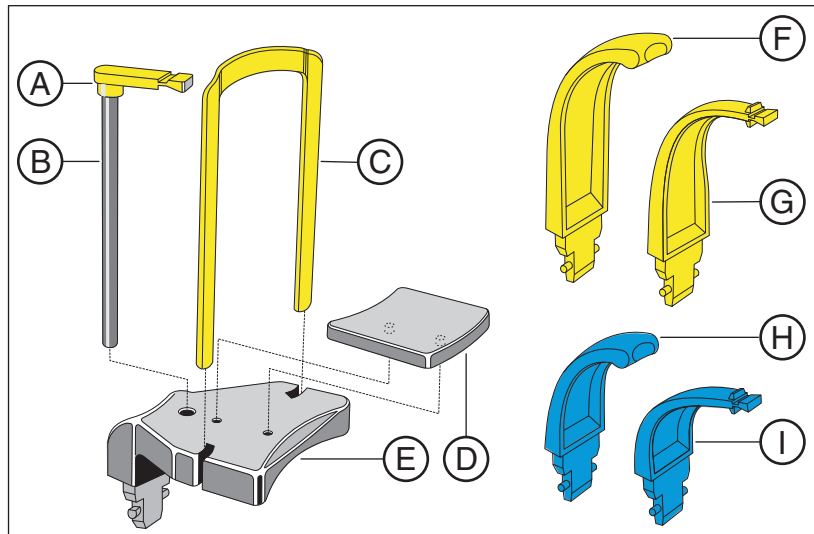

A	Bite block (10 pieces) REF 18 88 887
B	Bite block rod (5 pieces) REF 18 88 895
C	Bar for chin rest REF 59 61 461
D	Rest REF 14 49 227
E	Chin rest assembly, including A (5 pieces), B (1 piece), C, D, protective sleeves for bite block (500 pieces), protective sleeves for chin rest and bar (100 pieces), see "Hygiene protective sleeves" [→ 39] REF 59 81 472
F	Contact segment yellow for subnasale (5 pieces) REF 89 31 545
G	Bite block yellow (5 pieces) REF 89 21 843
H	Contact segment blue for subnasale (5 pieces) REF 89 31 552
I	Bite block blue (5 pieces) REF 89 21 850

3.5.1.2 3D bite block and spherical bite blocks

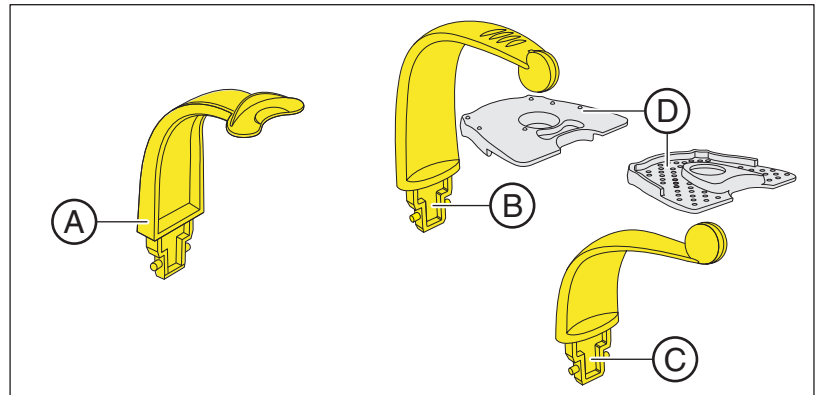

A	3D bite block rod (5 pieces) REF 61 34 949
B	Lower jaw spherical bite block (with symbol for UK) (1 piece) REF 61 50 226
C	Upper jaw spherical bite block (with symbol for UK) (1 piece) REF 61 50 218
D	Spherical bite block plate with markers for creating implant surgical guides Available at the online shop of SICAT www.sicat.com

3.5.1.3 Universal and occlusal bite block

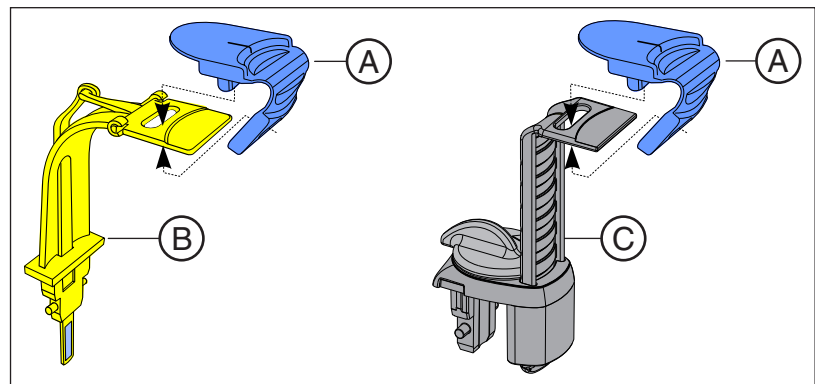

A	Bite block foam, single use device (100 pieces) REF 61 41 449
B	Occlusal bite block REF 62 11 143
C	Universal bite block REF 61 41 431

3.5.1.4 Temple supports, forehead support, and temporomandibular joint supports

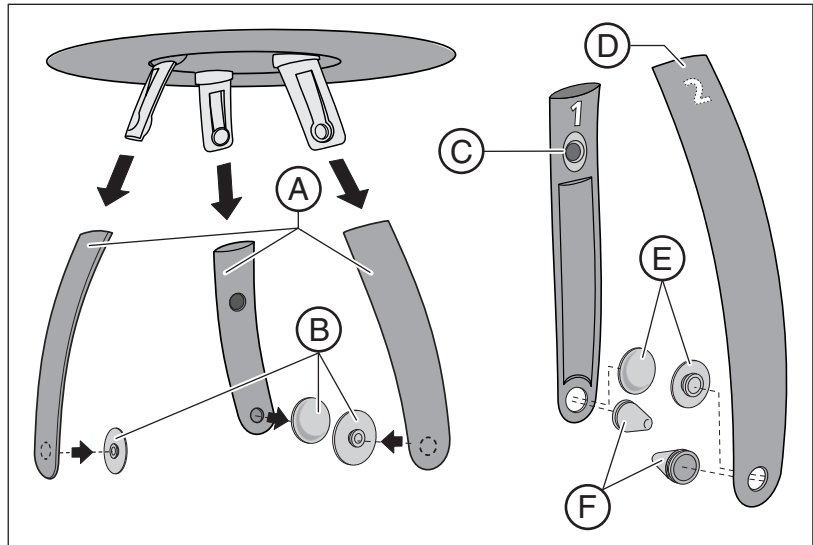

A	Forehead support and temple supports (1 piece) REF 64 84 989
B	Contact pads for forehead and temple supports (1 set) REF 64 85 010
C	Temporomandibular joint support 1 for temporomandibular joint exposures REF 64 84 997
D	Temporomandibular joint support 2 for temporomandibular joint exposures REF 64 85 002
E	Contact pads for temporomandibular joint supports (10 pieces) REF 59 90 648
F	Ear holders for temporomandibular joint supports (10 pieces) REF 18 88 838

3.5.2 Hygienic protective sleeves

Identification of single use devices



Prior to each exposure, the hygienic protective sleeves (single use devices) must be fitted.

Single use devices are identified with the symbol shown on the left. They must be disposed of immediately after use. Do not use single use devices more than once.

3.5.2.1 Protective sleeves for the basic unit

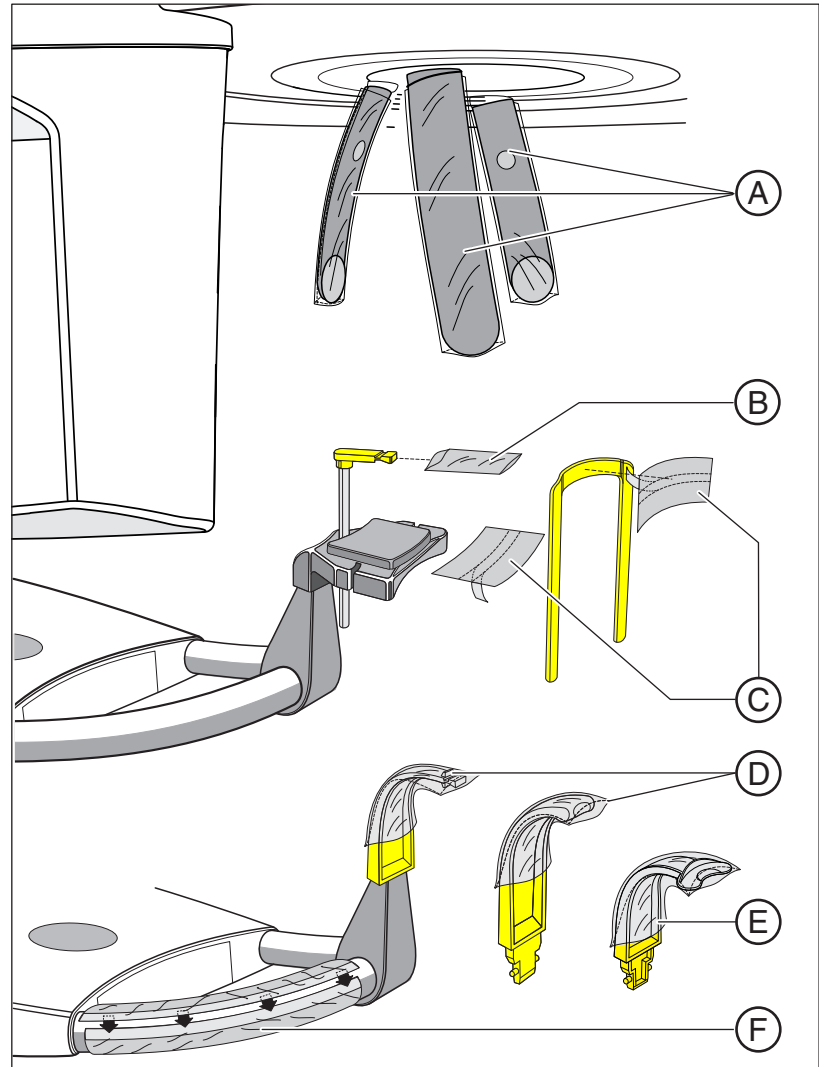

A	For forehead support and temple supports (500 pieces) REF 59 68 263
B	For bite block dimensions, 43 x 21 mm (500 pieces) REF 33 14 072
C	For chin rest and bar (100 pieces) REF 59 32 603
D	For bite blocks and contact segments (500 pieces) REF 33 14 080

E	For 3D bite block (500 pieces) REF 61 27 745
F	Protective sleeve for hand grips REF 59 68 255

3.5.2.2 Protective sleeves for cephalometer

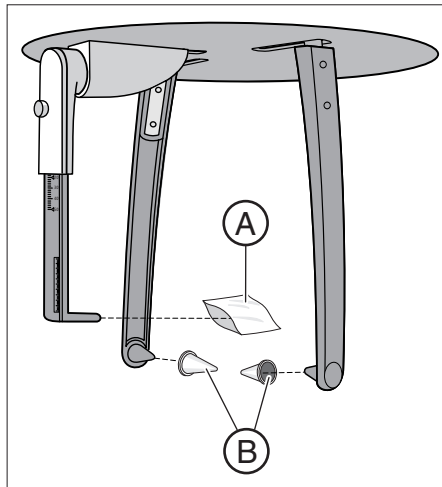

A	Protective sleeve for nose support, single use devices (100 pieces) REF 33 14 106
B	Protective caps for ear plugs, reusable devices (20 pieces) REF 89 32 261

3.5.3 Test phantom for acceptance/constancy test

Worldwide

At regular intervals, perform constancy tests according to the specifications for operating an X-ray unit in order to ensure the safety of operating staff and patients. Dentsply Sirona recommends monthly testing.

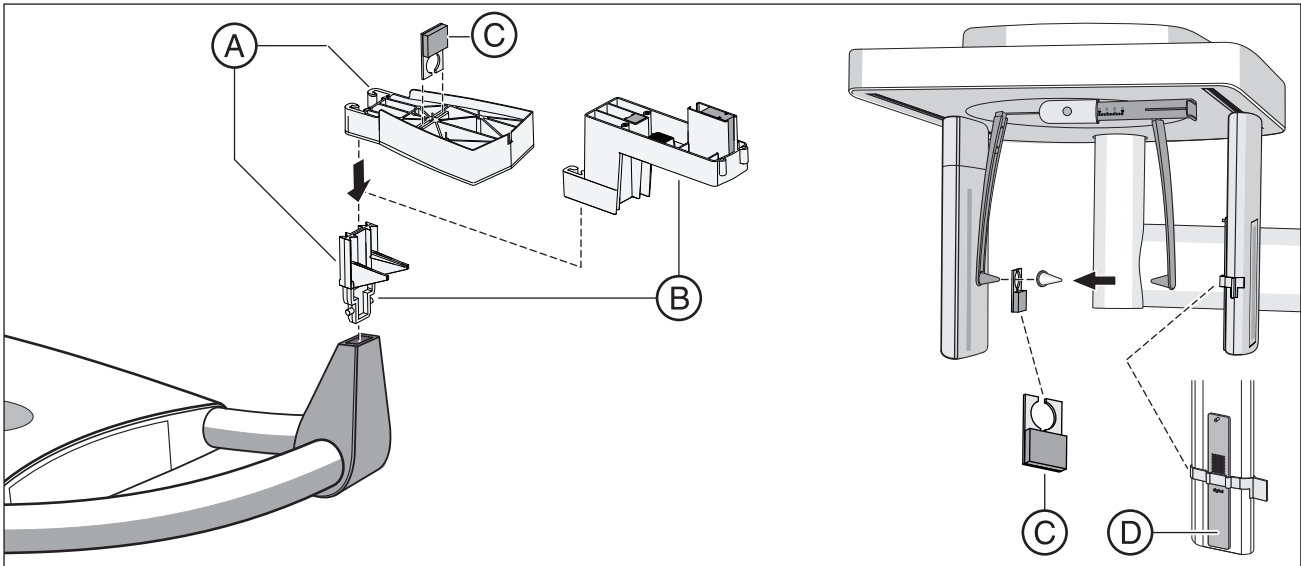

A	Exposure phantom, complete, spare (for 2D test) REF 59 85 416
B	Constancy test phantom, spare (for 3D test) REF 61 40 813
C	Contrast element OP SL, spare REF 64 90 895 (not in the scope of supply for all countries)
D	Test phantom Ceph REF 59 79 419 (not in the scope of supply for all countries)

4 Installation and start-up

Please also see the chapter titled: "Cleaning and care [-> 134]"

4.1 Replacing accessories on the basic unit

4.1.1 Replacing the bite block, contact segment, 3D bite block or chin rest

You will need to replace accessory parts according to the patient or exposure program.

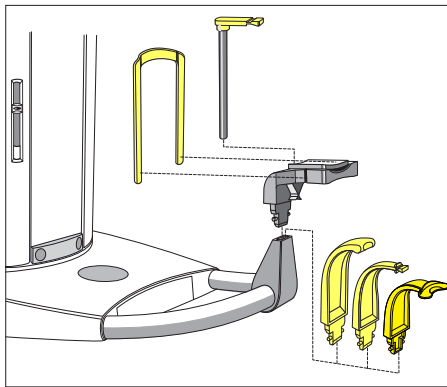

1. Pull the accessories upwards and out of the holder.
 - ↳ The accessory part disengages.
 2. Insert the bite block, contact segment, 3D bite block or chin rest.
 - ↳ The bite block, contact segment, 3D bite block or chin rest engages in position.
- ↳ The accessory has been replaced.

The chin rest can be combined with the bite block rod or the bar.

- > Insert the rod for the bite block or the bar into the chin rest from above.

4.1.2 Using the occlusal bite block

The occlusal bite block can be used for all panoramic and 3D exposures (except temporomandibular and sinus exposures) in place of the yellow bite block or contact segment. The angle of the bite block plate is transmitted to the X-ray unit. The displays on the touchscreen and the color change of the height adjustment buttons for adjusting the unit height and an automatic stop function assist the user in positioning the patient. An interchangeable bite block foam is used for the bite block, which can also be used for patients without anterior teeth.

Bite block foam (single use device), 100 pieces
REF 61 41 449



Inserting the bite block foam

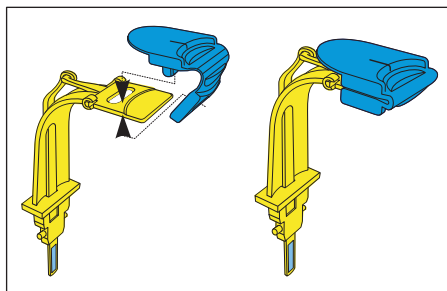

1. Insert the plug of the top section into the opening on the bite block plate.
2. Fold the bite block foam downwards.
3. Place the lower section onto the plug of the top section.

Inserting the occlusal bite block

NOTE

A contact for transmitting the angle to the X-ray system is located on the occlusal bite block.

The contact can be broken off or bent during insertion, removal, and storage.

- > Be careful not to damage the contact.
- > Prior to taking patient X-rays, check the function of the occlusal bite block described in this section.

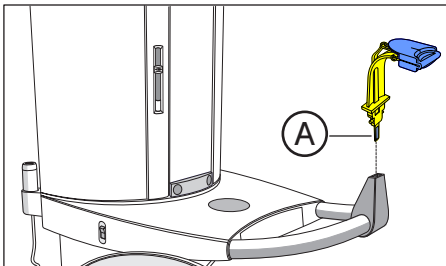

- > Insert the occlusal bite block into the bite block holder on the unit.
 - ↪ The head symbol on the touchscreen changes as soon as the contact **A** is inserted into the unit; a green arrow may appear, indicating the direction in which the height needs to be adjusted. When the head is properly aligned, the green arrows on the head symbol disappear.

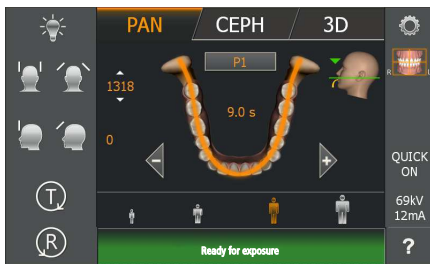

- ↪ The height adjustment buttons light up depending on the biting position.
 - Only one of the two buttons is ever green. The green button indicates the direction of movement of the stand required to achieve the best possible patient positioning.
 - Both buttons become blue if the optimum position is achieved and no further change to the height is necessary.
 - The height adjustment can be moved upwards and downwards irrespective of the lighting of the buttons. The color of the button is just a suggestion!

4.1.3 Using the universal bite block



The universal bite block can replace all other bite blocks and contact segments. An interchangeable bite block foam is used for the bite block, which can also be used for patients without anterior teeth.

Bite block foam (single use device), 100 pcs.
REF 61 41 449

Inserting the bite block foam

1. Insert the plug of the top section into the opening on the bite block plate.
2. Fold the bite block foam downwards.
3. Place the lower section onto the plug of the top section.

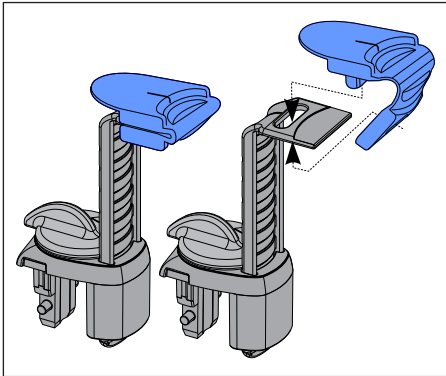

Adjusting the bite block height

The colored marking lines on the bite block slider are identical to the colors of the bite blocks. These correspond to the same bite block height.

The yellow marking has the same meaning as the bite block height of the yellow standard bite block or contact segment for the panoramic and bite wing exposures: P1, P2, P10, P12, BW1 and BW2.

If the mandibular ramus is not displayed on the exposure and parts of the sinus region are not necessarily of interest, then use the red marking.

The blue marking has the same meaning as the bite block height of the blue bite block or contact segment for sinus exposures: S1, S3.

The green marking is for maxillary exposures, where the alveolar ridge of the patient's head is aligned horizontally to position the patient a little lower in relation to the beam path.

The gray, black and white color markings offer further grid positions each with a position distance of 1 cm, in order to distinguish between the yellow and blue color marking.

1. Insert the universal bite block into the unit.
2. Open the lock with the rotary knob (A).
3. Adjust the bite block slider (B), according to the required bite block height, to the colored marking lines and lock this setting in place with the button (A).

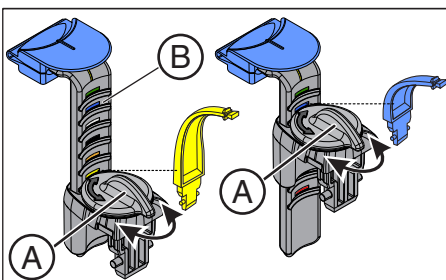

IMPORTANT

For programs BW1 and BW2, the universal bite block must **not** be used above the black marking. The positioning is otherwise too low.

4.1.4 Using spherical bite blocks and the spherical bite block plate

Two spherical bite blocks are available for preparing an implant drilling template for measuring scans of the upper or lower jaw.

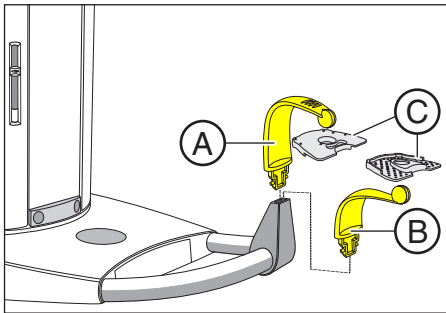

1. Insert the spherical bite block for mandibular exposures **(A)** (sphere-down) and the spherical bite block for maxillary exposures **(B)** (sphere-up) in the unit.
2. Position the spherical bite block plate **(C)** onto the sphere of the corresponding spherical bite block.

The spherical bite block plate **(C)** contains 6 radiopaque markers (spheres) which are used for orientation in the X-ray volume. Further applications can be set up on this spherical bite block plate.

4.1.5 Changing the temple supports and temporomandibular joint supports

For temporomandibular joint views, the temporomandibular joint supports **(A)** "1" right and **(C)** "2" left must be inserted in place of the temple supports **(B)**.

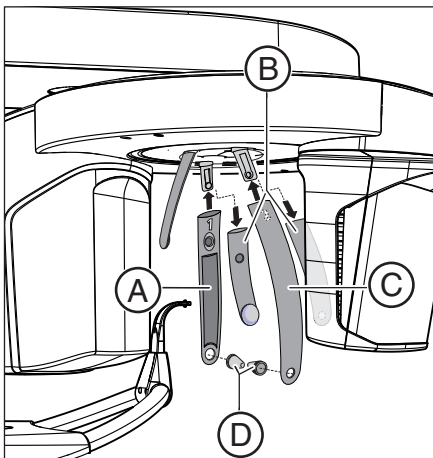

- ✓ Temple supports are inserted in the unit.
1. Press the respective locking button and remove the temple supports **B**.
 - ↪ Both temple supports are removed.
 2. Plug a sterile ear holder **D** into each of the temporomandibular joint supports **A** and **C**.
 - ↪ The ear holders snap into the temporomandibular joint supports.
 3. Insert temporomandibular joint supports **A** and **C** into the holders on the device.
 - ↪ The temporomandibular joint supports snap into place.
- ↪ The unit is converted for temporomandibular joint exposures.

4.2 Adjusting/inserting accessory parts on the cephalometer

Adjusting the holder for ear plugs

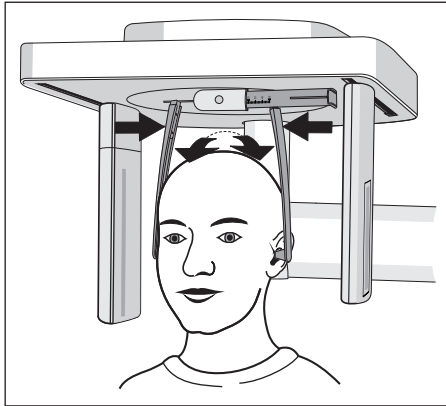

1. Grasp the ear plug holders at the very top with both hands.
2. Simultaneously pull the holders apart or push them together.
 - ↳ The ear plugs are inserted into the patient's outer ear canal.

Adjusting the nose support

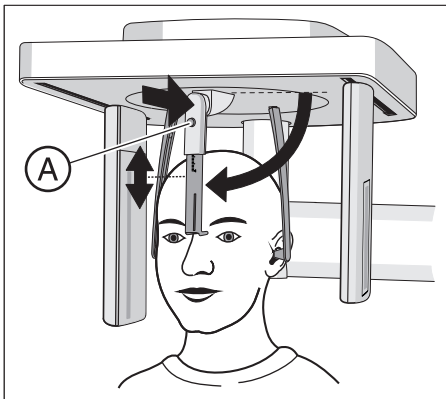

1. Fold down the nose support.
2. Lightly press and hold latching button (A).
 - ↳ The vertical adjustment is released.
3. Move the blue section of the nose support upwards or downwards.
4. Release latching button (A).
 - ↳ The vertical adjustment of the nose support is latched in position.

Inserting the carpus support plate

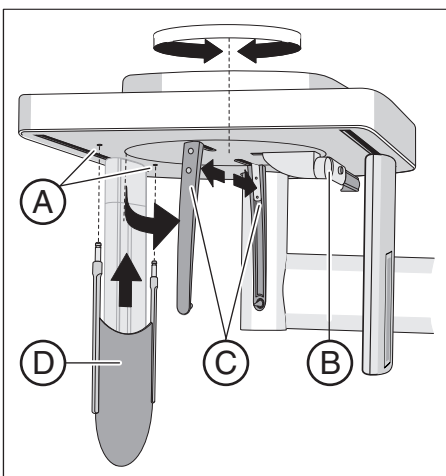

- ✓ The holders for the ear plugs (C) stand in line with the sensor and the secondary diaphragm.
1. Grasp the ear plug holders (C) at the very top with both hands. Simultaneously twist the holders by 90 degrees.
 - ↳ The nose support (B) is on the side facing away from the carpus support plate (D).
 2. Grasp the carpus support plate (D) by its sides.
 3. Insert the carpus support plate into both holes (A) until it reaches a stop.
 - ↳ The carpus support plate (D) engages with a slight resistance.

4.3 Removing/inserting the Ceph sensor

The Ceph sensor must always be inserted in order for the unit to be operated. However, should the Ceph sensor need to be removed, please proceed as follows:

Removing the sensor

1. Hold the sensor firmly.
2. Press the button all the way in and hold it.
↳ The sensor is released from the fastening.
3. Pull the sensor downwards out of the guide.

Inserting the sensor

1. Hold the sensor firmly.
2. Using both guide pins, insert the sensor into the guide sleeves on the unit and push until it reaches a stop.
↳ The sensor engages in the X-ray unit.

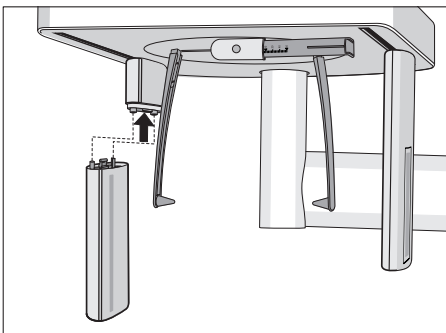

NOTE

When the sensor is being removed, it could be damaged by impact or if it is dropped.

The sensor contains an integrated vibration sensor to detect impacts or falls. If the vibration sensor has triggered, guarantee claims become void.

- > Do not drop the sensor under any circumstances!

NOTE

Electrostatic charges from persons are discharged on the unit.

This will destroy electrical components in the unit.

- > Do not touch any electrical components or unprotected plug contacts.
- > Discharge yourself by touching a conductive grounded object.

5 Operation

5.1 Acquiring the X-ray image

5.1.1 Switching the unit on and starting the software

5.1.1.1 Switching the unit on

⚠ CAUTION

Malfunctions can occur when the unit is switched on.

A patient positioned in the unit may be injured by moving parts.

- Please ensure that a patient is not positioned in the unit when activating the unit and selecting the operating mode (up until the completion of sensor positioning).

NOTE

Fluctuations in temperature can cause condensation to form in the unit.

Electrical components are destroyed by short circuits.

- Do not switch the unit on until the temperature of the unit has adapted to the ambient temperature and the condensation has evaporated. See the chapter on 'Technical data'.

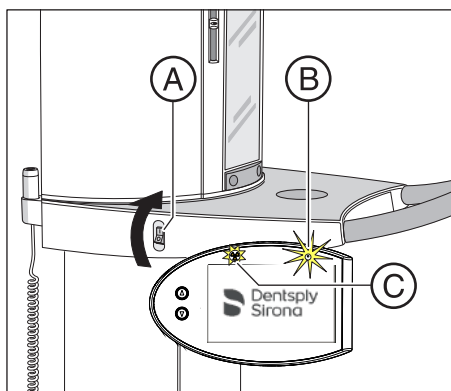

- ✓ The unit is properly installed.
- ✓ The unit is connected to the mains.
- 1. Turn the main switch **A** to position I.
- 2. Wait for one minute.
- ↻ The LED **(B)** lights up on the Easypad.
- ↻ The radiation indicator **(C)** lights up for approx. one second as a functional check.
- ↻ The home screen is displayed on the touchscreen for approximately 1 minute.
- ↻ The program selection is then displayed on the touchscreen.
- ↻ The forehead support and temple supports are completely open.

NOTE

The unit must not be switched on/off constantly.

Constant switching on and off reduces the service life of individual unit components and results in increased power consumption.

- After switching the unit off, wait for approx. 60 seconds before switching it on again.

NOTE

The surface of the touchscreen is sensitive.

The touchscreen can be damaged or its surface scratched.

- Never use pointed objects such as ballpoint pens, pencils, etc. to operate the touchscreen.
- Only use your fingertips to operate the touchscreen.

5.1.1.2 Enabling exposure readiness in Sidexis 4

NOTE: The procedures for starting Sidexis 4, for logging in a patient, and for selecting the processing step "Exposure" can be found in the technical document "Sidexis 4 Operator's Manual" (REF 64 47 028).

- ✓ Sidexis 4 must have been started.
- ✓ A patient must be logged in.
- ✓ The processing step "Exposure" must be selected.

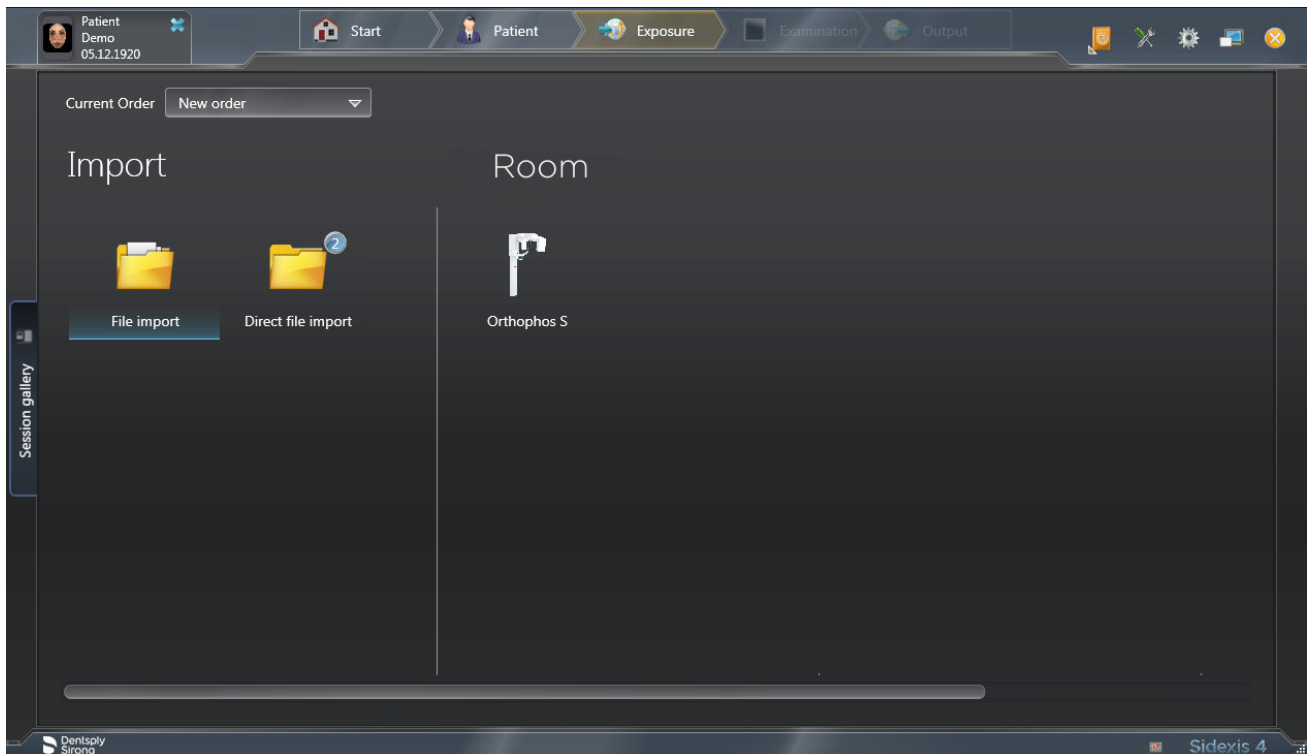

1. Select an X-ray unit for the exposure.



- ↳ The dialog for preparing the exposure appears.
- 2. Enter the indication for the exposure in the input field "Indication".
- 3. Activate or deactivate the check box "Patient pregnant".
- 4. Click on the "Start acquisition" button.
- ↳ Sidexis 4 makes the unit ready for exposure.

5.1.2 Selecting an exposure program

5.1.2.1 Panoramic and bite wing exposure

5.1.2.1.1 Program descriptions

5.1.2.1.1.1 P1 – Panoramic exposure

The exposure displays the full tooth region with ascending rami.

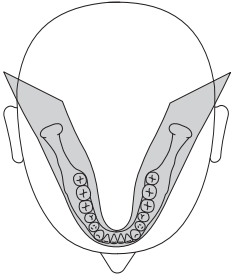

P1 A – Panoramic exposure, artifact-reduced

The exposure can be taken in an artifact-reduced format to avoid artifacts in the condylar and molar regions, and to reduce shadowing by the opposite jaw.



P1 C – Panoramic exposure, constant 1.25x magnification

The exposure can be taken at a constant magnification of 1.25x, for example, for implantology.

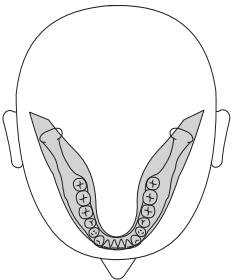

5.1.2.1.1.2 P2 – Panoramic exposure, without ascending rami

The exposure represents a reduced tooth region without ascending rami.

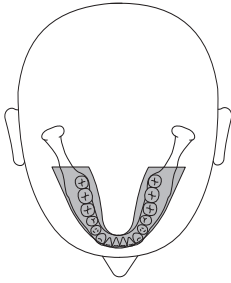

P2 A - Artifact-reduced panoramic exposure without ascending rami

The exposure can also be taken in an artifact-reduced format to avoid artifacts in the condylar and molar regions, and to reduce shadowing by the opposite jaw.

P2 C - Panoramic exposure without ascending rami at a constant magnification of 1.25x

The exposure can be taken at a constant magnification of 1.25x, for example, for implantology.

5.1.2.1.1.3 P10 – Panoramic exposure for children

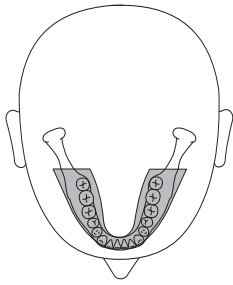

The exposure represents a reduced tooth region without ascending rami. For this exposure the radiation dose is considerably reduced.

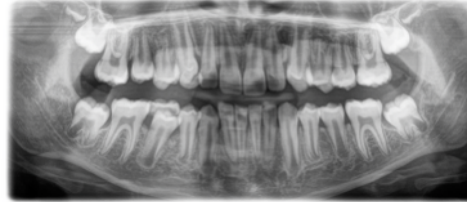

P10 A – Panoramic exposure for children, without ascending rami, artifact-reduced

The exposure can also be taken in an artifact-reduced format to avoid artifacts in the condylar and molar regions, and to reduce shadowing by the opposite jaw. For this exposure the radiation dose is considerably reduced.

P10 C – Panoramic exposure for children, without ascending rami, constant 1.25x magnification

The exposure can be taken at a constant magnification of 1.25x, for example, for implantology. For this exposure the radiation dose is considerably reduced.

5.1.2.1.1.4 P12 – Thick slice, anterior tooth region

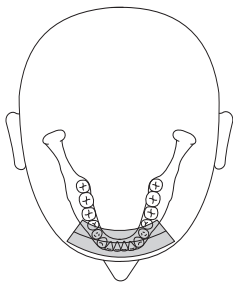

The exposure shows the anterior tooth region with a larger slice thickness, e.g. for implantology.

The image section can be selected for UJ/LJ.

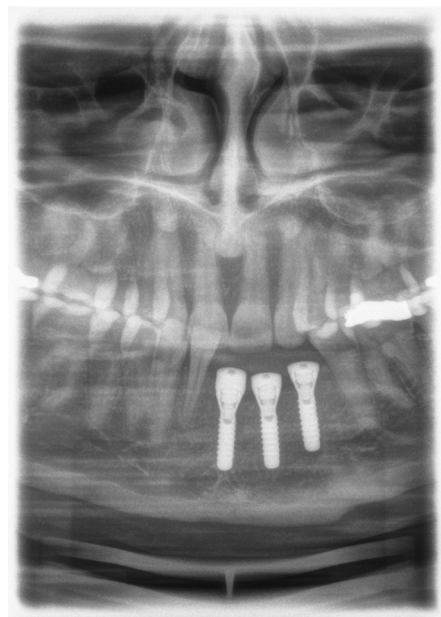

5.1.2.1.1.5 BW1 – Bite wing exposure in the posterior tooth region

The exposure displays the posterior tooth regions with an image height restricted to the bite wing and an optimized projection.

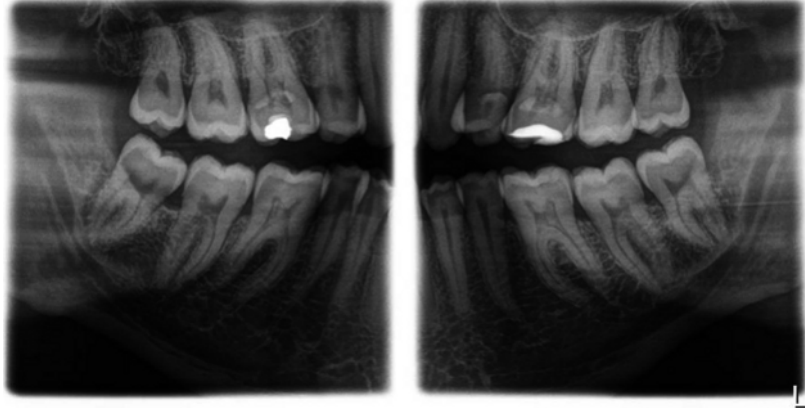
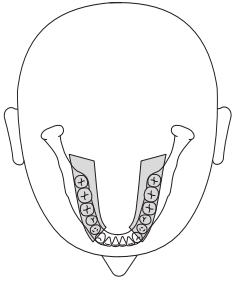

5.1.2.1.1.6 BW2 – Bite wing exposure in the anterior tooth region

The exposure displays the anterior tooth regions with an image height restricted to the bite wing and an optimized projection.

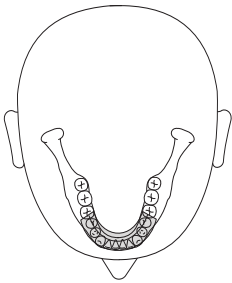

5.1.2.1.2 Preparing the exposure

Depending on the patient or the exposure program, accessory parts must be replaced and the appropriate exposure mode must be selected; see "Installation and start-up" [-> 42].

You will require the following accessories:

- Chin rest with bite block rod or bar or yellow bite block or contact segment or universal bite block or occlusal bite block.

CAUTION

The chin rest must **not** be used for children when using programs BW1 and BW2. The positioning is otherwise too low.

IMPORTANT

For programs BW1 and BW2, the universal bite block must **not** be used above the black marking. The positioning is otherwise too low.

- Temple supports
- Forehead support
- > Insert the accessory parts to be used into the unit and pull on the relevant hygienic protective sleeves, see "Hygienic protective sleeves" [-> 39].
- > Switch SIDEXIS to a ready-for-exposure state; see 'Switch SIDEXIS to ready-for-exposure state'.

5.1.2.1.3 Selecting an exposure program

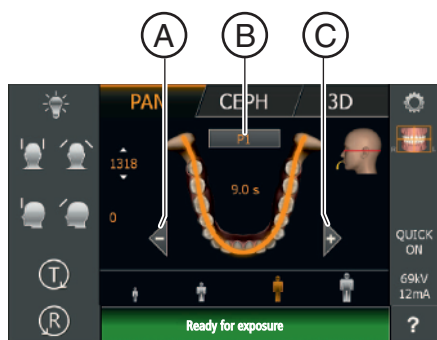

⚠ CAUTION

Pressing the R key moves the unit to the starting position.

A patient positioned in the unit may be injured by moving parts.

- Check that a patient is not positioned in the unit before moving it to the starting position.

- ✓ The unit is switched on and ready for exposure.
- 1. Touch the PAN symbol at the top of the touchscreen.
 - ↳ The program group PAN is selected.
- 2. Select an exposure program. To do this, touch the arrow keys + C and -A. If a subroutine, e.g. without artifacts or 1.25x magnification, is available for this program, the program display is grayed out. Touch the program display B several times. All subroutines of the selected program are displayed one by one.
- 3. Follow the instructions in the comment line on the touchscreen. If required, press the R key to move the unit back to the starting position.
 - ↳ The diaphragm and the sensor move into the starting position.
 - ↳ The exposure program is selected.

NOTE

The PAN/3D sensor unit is rotated via a motor drive.

The gearing of the sensor unit can be damaged if it is turned by hand.

- Press the R key to rotate the sensor unit back to the starting position via the motor drive. The sensor unit is always rotated in combination with the entire main rotation unit. The combisensor travels to the proper starting position for panoramic, Ceph, or 3D exposures, depending on the program group selected.

5.1.2.1.4 Setting quadrants

The exposure can be restricted to quadrants. You can select a half-view of the right or left jaw in programs P1, P2, P10 and BW1, or upper jaw/lower jaw in programs P1, P2, P10 and P12. In P1, P2, P10, also for constant magnification and artifact-reduced view.

✓ Level 1 is displayed on the touchscreen.

1. Press the quadrant symbol **(A)** on the right side of the touchscreen.
 - ↳ A submenu line is opened.
2. Select the desired quadrant(s). See the figure below. Quadrants can be selected as half-views or individually. Touch the quadrant field in the center to reactivate the full frame.
 - ↳ The selected quadrants are emphasized / the non-selected ones are grayed out.

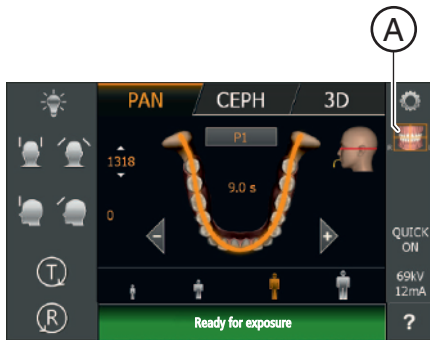

3. Touch the cross on the left side of the submenu line.
or
> Touch the quadrant symbol **(A)** again.
 - ↳ The submenu line is closed.
- ↳ The quadrant or quadrants are set.

IMPORTANT

The program duration for individual quadrant exposures equals the program duration for half-view exposures.

5.1.2.1.5 Adjusting the Quickshot function

✓ Level 1 is displayed on the touchscreen.

1. Touch the Quickshot display **A** on the right side of the touchscreen.
↳ A submenu line is opened.

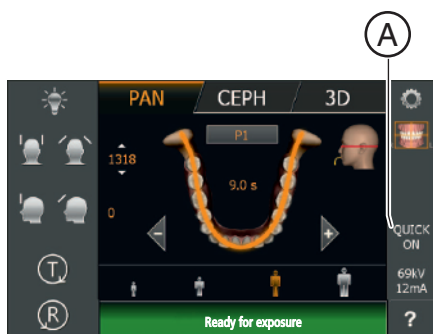

2. Press the *Quick On* or *Quick Off* icons on the touchscreen.
↳ The selection is highlighted orange in the submenu line.
3. Touch the cross on the left side of the submenu line.

or

- > Touch the Quick symbol (**A**) again.
↳ The submenu line is closed.
- ↳ The Quickshot function is set.

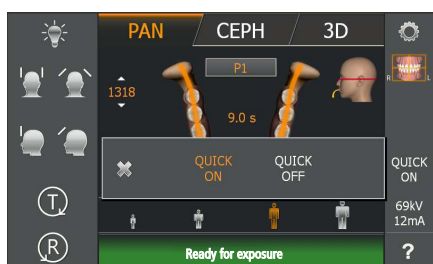

5.1.2.1.6 Setting the temple width

The set temple support width changes the radiation time slightly.
The slice width for different dental arches is automatically selected in P1, P2, P10 and their subprograms.

5.1.2.1.7 Setting the kV/mA values

Setting the kV/mA values via the patient symbols

Preset kV/mA combinations are assigned to the patient symbols, which are selected according to the patient's size and weight. The symbols roughly correspond to child, youth/woman, woman/man, hefty persons.

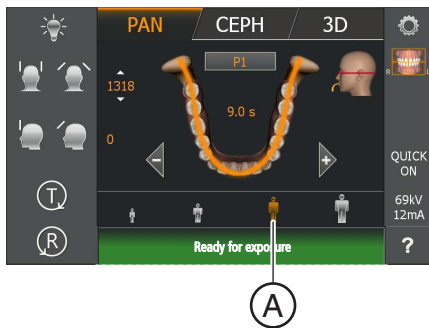

- ✓ Level 1 is displayed on the touchscreen.
- Touch the required patient symbol.
 - ↪ The selection **(A)** is highlighted in orange. The selected kV/mA value is displayed on the right side of the touchscreen.
- ↪ The kV/mA value is set.

Setting the kV/mA values via the submenu line

If the preset kV/mA combinations do not provide a satisfactory result, you can also set the kV/mA values manually in all programs.

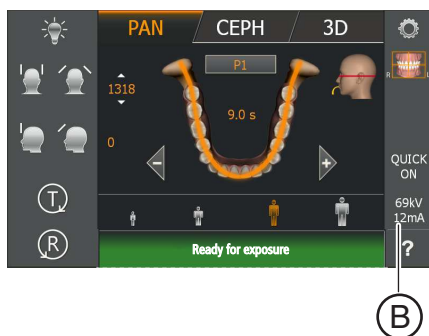

- ✓ Level 1 is displayed on the touchscreen.
- 1. Touch the kV/mA symbol **(B)** on the right side of the touchscreen.
 - ↪ A submenu line is opened.

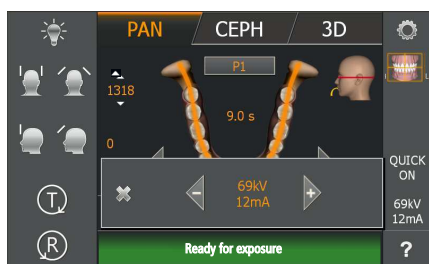

- 2. Select a kV/mA value. Touch the - or + keys.
 - ↪ The selected kV/mA value is displayed.
 - 3. Touch the cross on the left side of the submenu line.
- or
- Touch the kV/mA symbol **(B)** again.
 - ↪ The submenu line is closed.
 - ↪ The kV/mA value is set.

5.1.2.1.8 Positioning the patient

The patient is positioned on the unit while standing. Positioning in the seat is also possible without issue.

CAUTION

The height adjustment motor starts slowly and then increases its speed.

A patient positioned in the unit may be injured by moving parts.

- Monitor the patient and the movement of the unit during height adjustment. To make minor corrections, press and immediately release the keys. Release the button immediately in the event of involuntary contact between patient and device.

CAUTION

Hazard due to laser light.

Patients and users can be blinded by the laser light localizer.

- Prior to activating the laser light localizers, the patient **must** be asked to shut their eyes.
- Do not stare directly into the laser beam. Make sure that the laser beam does not meet the eyes of the patient.
- A distance of at least 10 cm must be maintained between the eye and the laser.

CAUTION

Reduced image quality

The image quality is limited by metal or other radiopaque materials located in the patient's mouth and in its vicinity.

- Ask the patient to take off all metallic objects such as glasses and jewelry in the head and neck area as well as all removable dental prostheses. The tray in front of the control mirror is used for depositing jewelry.

Tip: Reference values are shown for the height and forehead support settings, which are saved for further exposures in the additional information area of the SIDEXIS software.

5.1.2.1.8.1 Positioning with an occlusal bite block

The occlusal bite block sets the inclination according to the occlusal plane instead of the standard Frankfurt horizontal plane. This results in fewer overlaps in the anterior tooth region and upper jaw.

If required, the service engineer can adjust the angle to the Frankfurt horizontal plane in order to preset the Frankfurt horizontal plane (see Service Manual).

- ✓ The occlusal bite block with bite block foam is inserted in the unit. The green arrows are displayed on the touchscreen.
- ✓ The forehead support and temple supports are inserted in the unit. The hygienic protective sleeves are pulled on.

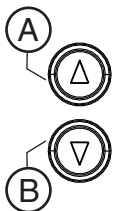
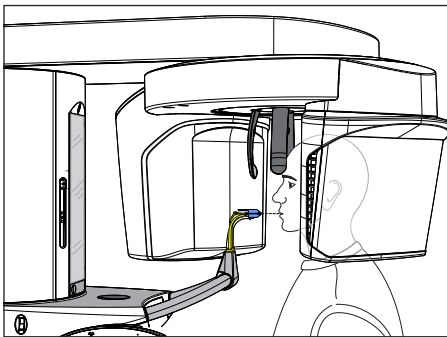

1. Guide the patient in front of the control mirror.
2. Set the unit height using the up **A** and down **B** keys. The height adjustment buttons are illuminated and show the direction in which the unit is to be moved by a green arrow.
CAUTION! The height adjustment motor starts slowly and then increases its speed.
Press and hold down the button until the desired height is reached. The unit movement is accompanied by a beep. Release the height adjustment buttons once the bite block plate and the patient's anterior teeth are at the same height.
3. Guide the patient to the unit and instruct them to hold the handles with both hands.
4. Instruct the patient to bite into the grooves of the bite block foam with the teeth.
 - ↳ If necessary, push the lower anterior teeth forwards until they reach a stop.

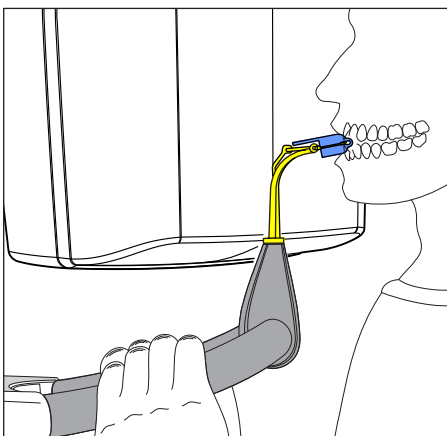

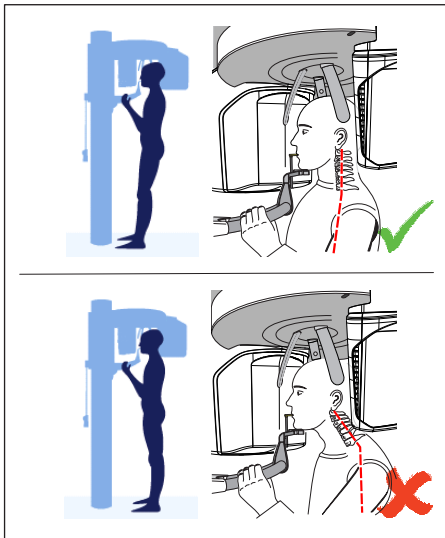

5. Check the position of the patient's spine.

- ↪ Ensure that the patient's spine is slightly inclined, as shown in the diagram.

Tip: To achieve the correct positioning of the spine, ask the patient to take a small step towards the column of the unit. The patient's cervical vertebrae are thus stretched. This prevents shadowing of the anterior tooth region on the X-ray.

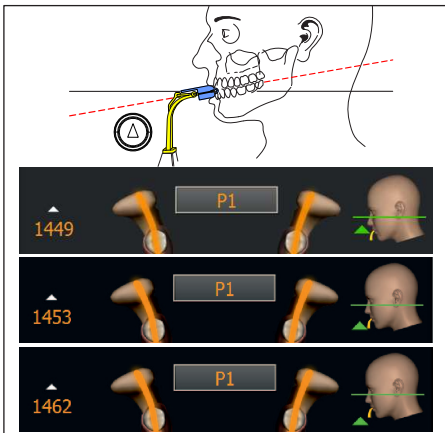

6. Use the green arrows on the touchscreen to align the patient's head inclination until the desired position is reached. Instruct the patient to let their head rest.

- ↪ If the green arrow on the touchscreen points up, press the button for height adjustment **A** upwards.

CAUTION! If no change in the angle of the bite block plate is found for about 3 seconds, the height adjustment motor runs at a higher speed.

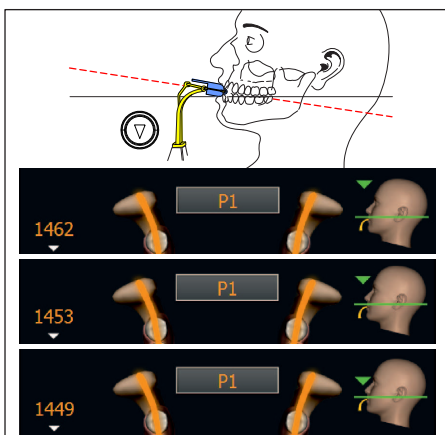

7. When the green arrow points downwards, press the down button **B**.

- ↪ The inclination of the patient's head changes according to the height of the unit. While the angle of the bite block plate is being changed, the unit height can only travel at a very slow speed.
- ↪ The green arrow on the head symbol indicates how far the unit height must be moved until the nominal position for head inclination is reached. The inclination of the displayed head symbol also changes accordingly.
- ↪ Once the desired position is reached, the movement stops automatically and a beep is sounded by the user interface. The green-illuminated arrows of the height adjustment buttons light up blue.



8. Switch on the light localizer. **CAUTION! Risk of dazzle**

- ↪ Two red laser lines reflect on the patient's head. To switch off the light localizer, press the key again. It switches off automatically after approx. 100 seconds.

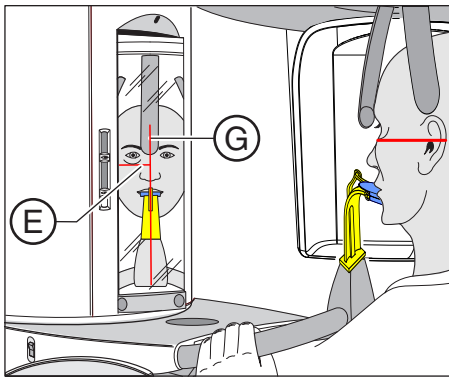

9. Align the patient with the central laser line **G**.
 - ↳ The laser line reflects in the center of the patient's anterior teeth or the middle of the face (mid-sagittal).

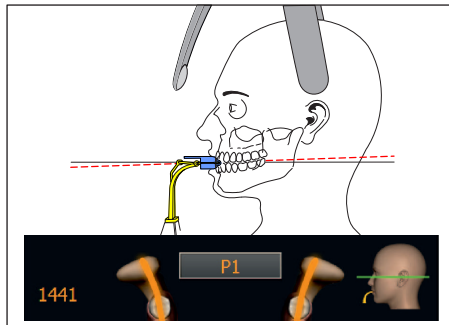

10. If necessary, check the patient's position. Briefly press the up **A** and down **B** height adjustment keys.

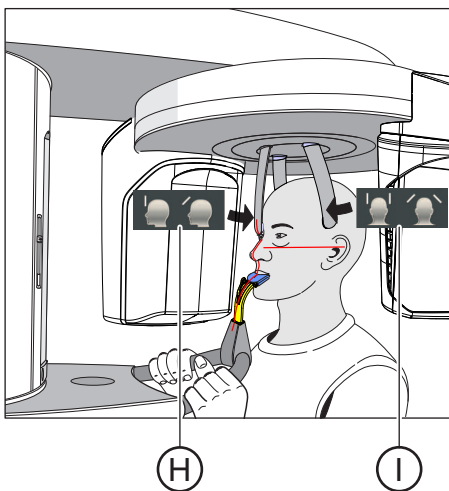

11. Press the temple support adjustment button **I**.
 - ↳ When you touch the patient's head, the temple supports stop automatically.
12. Press the forehead support adjustment key (**H**).
 - ↳ When you touch the patient's head, the forehead support stops automatically.
Make sure that the patient's head does not move backwards when placing the forehead support.
13. Instruct the patient to exhale, place his tongue against the roof of his mouth, and hold this position until the end of the exposure.
 - ↳ The patient is positioned in the unit.

If the occlusal bite block is stuck in the bite block holder even after the exposure is carried out and you select an exposure program that is not intended for the use of the occlusal bite block, the help message 'H307 - Change bite block' will appear in the comment line. Insert the relevant bite block or contact segment required for the exposure. The help message disappears as soon as the occlusal bite block is removed.

IMPORTANT

In P1, P2, P10, the slice width is selected automatically for different dental arches with the temple support setting, and the radiation time is also changed slightly through this in accordance with the temple support width which is set.

5.1.2.1.8.2 Positioning with chin rest and rod for bite block

- ✓ The chin rest and bite block segment, as well forehead support and temple supports are inserted in the unit.
- ✓ The relevant hygienic protective sleeves are pulled over the accessories.

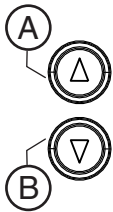
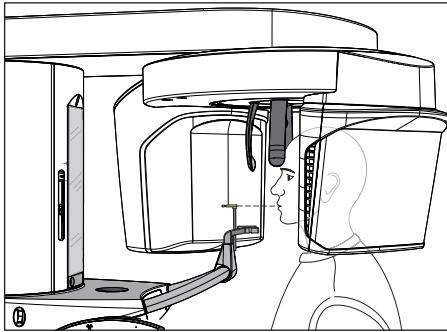

1. Guide the patient in front of the control mirror.
2. Set the unit height using the up **A** and down **B** keys.
CAUTION! The height adjustment motor starts slowly and then increases its speed.
Press and hold down the button until the desired height is reached. The unit movement is accompanied by a beep. Release the height adjustment buttons once the patient's chin and the chin rest on the unit are at the same height.
3. Turn the bite block away from the patient.
 - ↳ The bite block is pointing towards the control mirror.
4. Instruct the patient to place his chin on the chin rest and place both hands on the hand grips.
5. Turn the bite block towards the patient and instruct him to bite on the bite block.
 - ↳ The patient's anterior teeth are positioned in the indentation in the bite block. If necessary, push the lower anterior teeth forwards until they reach a stop.

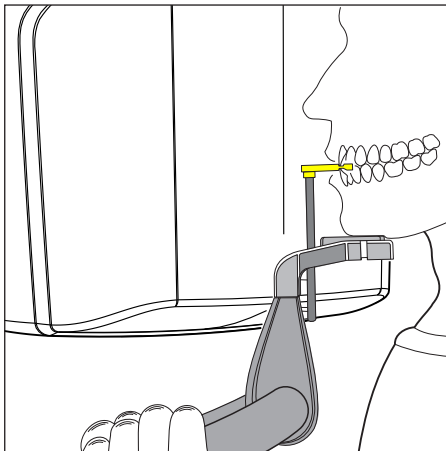

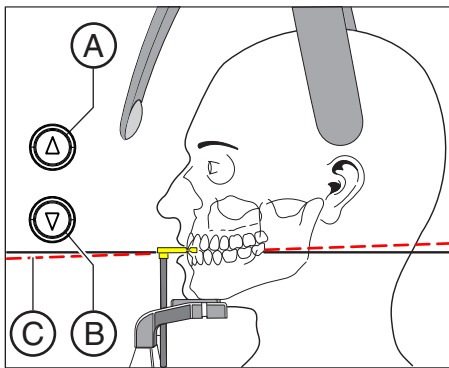

6. Check the patient's occlusal plane **C**. Adjust the unit height using the up (**A**) and down (**B**) keys.
 - ↪ The occlusal plane is slightly inclined toward the front.

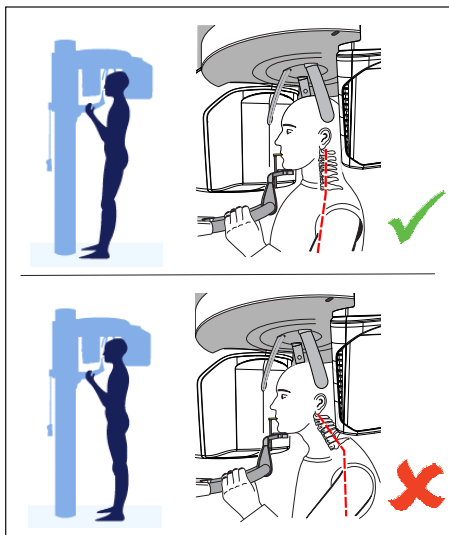

7. Check the position of the patient's spine.
 - ↪ Ensure that the patient's spine is slightly inclined, as shown in the diagram.

Tip: To achieve the correct positioning of the spine, ask the patient to take a small step towards the column of the unit. The patient's cervical vertebrae are thus stretched. This prevents shadowing of the anterior tooth region on the X-ray.
8. Swivel the control mirror outwards. Press the left recess on the touchbar **D**.
 - ↪ You can see the patient in the control mirror.



9. Switch on the light localizer. **CAUTION! Risk of dazzle**
 - ↪ Two red laser lines reflect on the patient's head. To switch off the light localizer, press the key again. It switches off automatically after approx. 100 seconds.

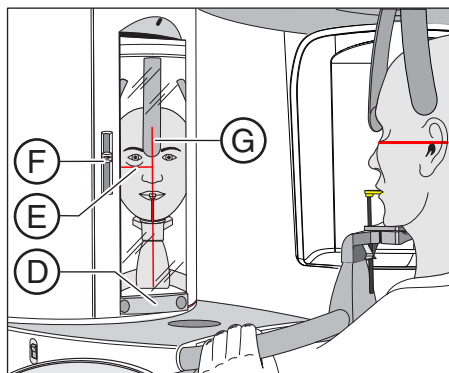

10. Align the patient with the central laser line **G**.
 - ↪ The laser line reflects in the center of the patient's anterior teeth or the middle of his face (mid-sagittal).

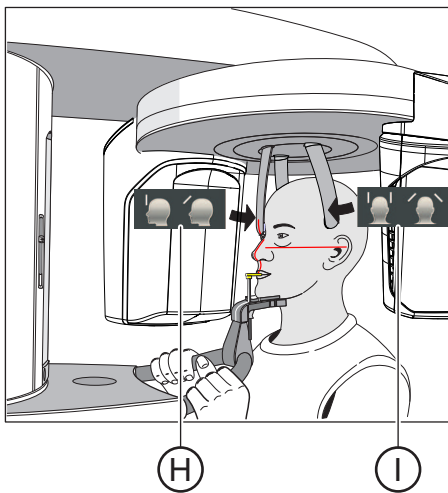
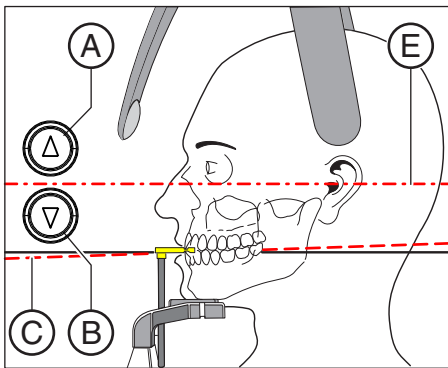

11. Align the patient's head according to the Frankfurt horizontal plane (E).
Tip: The Frankfurt horizontal is used as a reference plane. It runs between the upper edge of the ear canal and the deepest point of the lower eye socket edge.
12. Adjust the height of the light localizer using the slider F.
↳ The laser line reflects on the upper edge of the outer ear canal.
13. Correct the patient's head inclination as necessary. Briefly press the up A and down B height adjustment keys.
↳ The laser line reflects on the lowest point of the lower eye socket edge.
14. Press the temple support adjustment button I.
↳ When you touch the patient's head, the temple supports stop automatically.
15. Press the forehead support adjustment key (H).
↳ When you touch the patient's head, the forehead support stops automatically.
Make sure that the patient's head does not move backwards when placing the forehead support.
16. Check the patient's position and make any final corrections as necessary.
17. Swivel the control mirror back into place. Press the right recess on the touchbar D.
↳ The patient can see himself in the control mirror.
18. Instruct the patient to exhale, place his tongue against the roof of his mouth, and hold this position until the end of the exposure.
↳ The patient is positioned in the unit.

IMPORTANT

In P1, P2, P10, the slice width is selected automatically for different dental arches with the temple support setting, and the radiation time is also changed slightly through this in accordance with the temple support width which is set.

5.1.2.1.8.3 Positioning with chin rest and bar

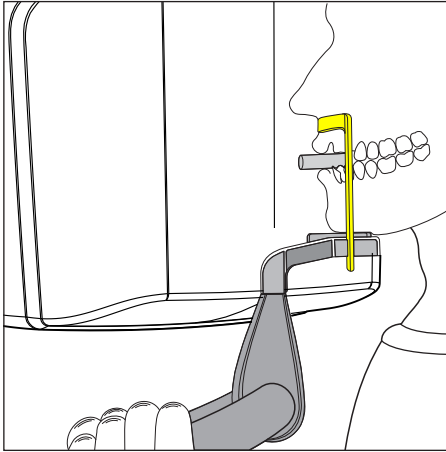

- ✓ The patient has no or only a few anterior teeth.
 - ✓ The chin support and bar, and the forehead support and temple supports are inserted in the unit.
 - ✓ The relevant hygienic protective sleeves are pulled over the accessories.
1. Instruct the patient to place his chin on the chin rest and place both hands on the hand grips.
 2. Instruct the patient to place his subnasale (the base of his nose) against the bar. If the patient's lower jaw contains anterior teeth, place the bar between his chin and his lower lip.
 3. Place a cotton roll between the patient's upper and lower jaw.
 - ↳ The patient's upper and lower jaw are aligned.
 4. Proceed as described under "Positioning with chin rest and rod for bite block" from step 6.

5.1.2.1.8.4 Positioning with bite block

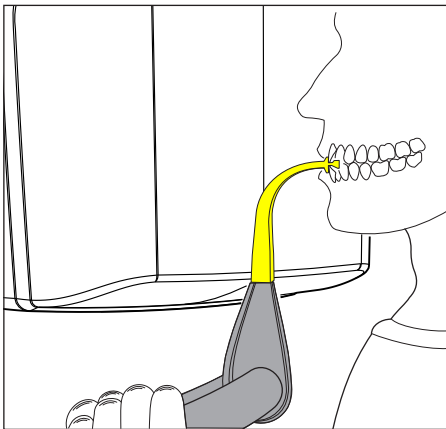

- ✓ The yellow bite block, forehead support and temple supports are inserted in the unit.
 - ✓ The relevant hygienic protective sleeves are pulled over the accessories.
1. Instruct the patient to hold the handles with both hands and bite into the bite block.
 - ↳ The patient's anterior teeth are positioned in the indentation in the bite block. If necessary, push the lower anterior teeth forwards until they reach a stop.
 2. Proceed as described under "Positioning with chin rest and rod for bite block" from step 6.

5.1.2.1.8.5 Positioning with contact segment

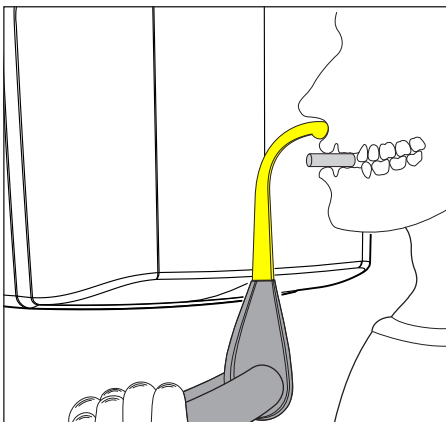

- ✓ The patient has no or only a few anterior teeth.
 - ✓ The yellow contact segment, forehead support and temple supports are inserted in the unit.
 - ✓ The relevant hygienic protective sleeves are pulled over the accessories.
1. Instruct the patient to hold the handles with both hands and place his subnasale (the base of his nose) against the contact segment.
 2. Place a cotton roll between the patient's upper and lower jaw.
 - ↳ The patient's upper and lower jaw are aligned.
 3. Proceed as described under "Positioning with chin rest and rod for bite block" from step 6.

5.1.2.2 Temporomandibular joint exposure

5.1.2.2.1 Program descriptions

IMPORTANT

Note the information on the two-part exposure programs in the "Releasing the exposure" chapter, see "Two-part exposure programs [→ 119]".

5.1.2.2.1.1 TM1.1 / TM1.2 – Lateral view of temporomandibular joints with mouth open and closed

(Two-part exposure program)

This exposure displays the temporomandibular joints from a lateral aspect with the mouth open and closed and provides 4 views in one image.

This program enables angle preselection (0°, 5°, 10°, and 15°) for the temporomandibular joint area.

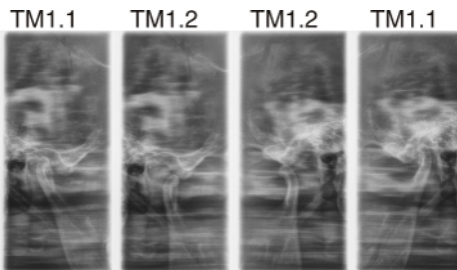
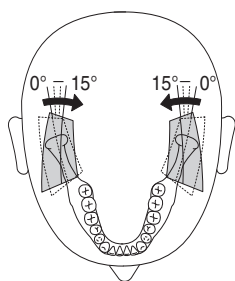

5.1.2.2.1.2 TM3 – Temporomandibular joints lateral, ascending rami

The exposure shows a lateral projection of the temporomandibular joints with ascending rami, with 2 views in one image.

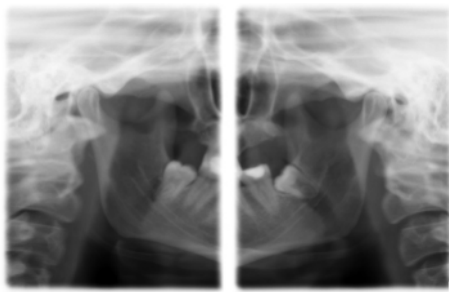
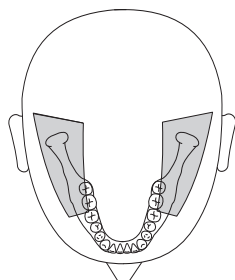

5.1.2.2.2 Preparing the exposure

Depending on the patient or the exposure program, accessory parts must be replaced and the appropriate exposure mode must be selected; see "Installation and start-up" [-> 42].

You will require the following accessories:

- Temporomandibular joint supports with ear holders
- Forehead support
- > Insert the accessory parts to be used into the unit and pull on the relevant hygienic protective sleeves, see "Hygienic protective sleeves" [-> 39].
- > Switch SIDEXIS to a ready-for-exposure state; see 'Switch SIDEXIS to ready-for-exposure state'.

5.1.2.2.3 Selecting an exposure program

CAUTION

Pressing the R key moves the unit to the starting position.

A patient positioned in the unit may be injured by moving parts.

- > Check that a patient is not positioned in the unit before moving it to the starting position.

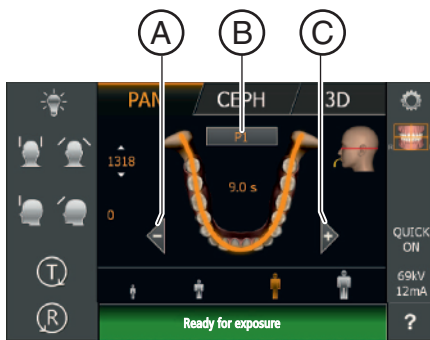

- ✓ The unit is switched on and ready for exposure.
- 1. Touch the PAN symbol at the top of the touchscreen.
 - ↳ The program group PAN is selected.
- 2. Select the exposure program. Press the arrow keys + C and - A.
 - ↳ The exposure program is displayed in the program display (B).
- 3. Follow the instructions in the comment line on the touchscreen. Press the R key if necessary.
 - ↳ The diaphragm and the sensor move into the starting position.
- ↳ The exposure program is selected.

5.1.2.2.4 Adjusting the angle preselection

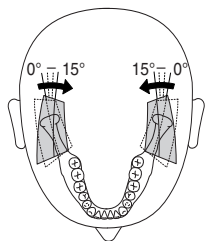

TM1

In the TM1 exposure program, angle (0°, 5°, 10° and 15°) can be preset for the temporomandibular joint area. This can be helpful if more detailed analyses of the temporomandibular joint are necessary, but the standard projections (0°) do not provide an optimal image.

The figure shows the direction in which the slice orientation is being swiveled during angle preselection.

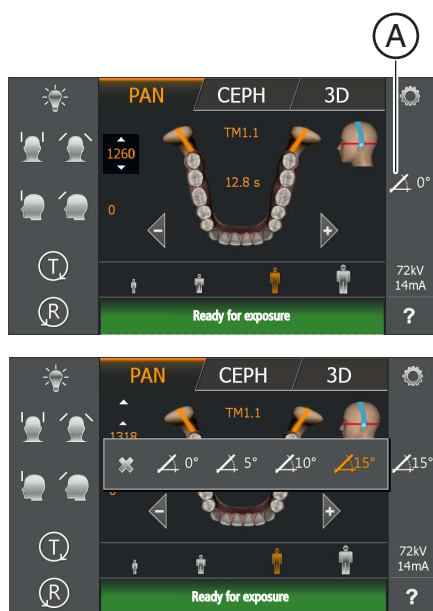

✓ Level 1 is displayed on the touchscreen.

1. Touch the angle preselection symbol **(A)** on the right side of the touchscreen.

↳ A submenu line is opened.

2. Select the corresponding angle preselection.

↳ The selection is highlighted orange in the submenu line. The selected angle preselection is displayed on the right side of the touchscreen.

3. Touch the cross on the left side of the submenu line.

or

> Touch the angle preselection symbol **(A)** again.

↳ The submenu line is closed.

↳ The angle preselection is set.

IMPORTANT

When you confirm the exposure with the R key, the angle setting that was changed in the submenu line will automatically be reset to the default setting of 0°.

5.1.2.2.5 Setting the kV/mA values

Setting the kV/mA values via the patient symbols

Preset kV/mA combinations are assigned to the patient symbols, which are selected according to the patient's size and weight. The symbols roughly correspond to child, youth/woman, woman/man, hefty persons.

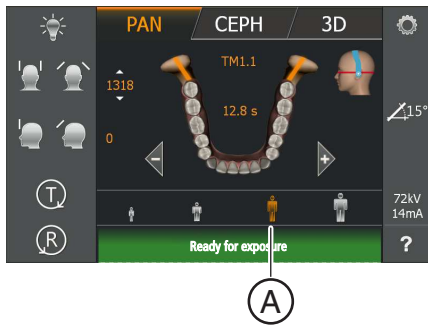

- ✓ Level 1 is displayed on the touchscreen.
- > Touch the required patient symbol.
 - ✦ The selection **(A)** is highlighted in orange. The selected kV/mA value is displayed on the right side of the touchscreen.
- ✦ The kV/mA value is set.

Setting the kV/mA values via the submenu line

If the preset kV/mA combinations do not provide a satisfactory result, you can also set the kV/mA values manually in all programs.

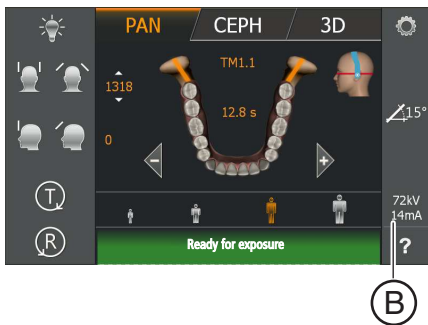

- ✓ Level 1 is displayed on the touchscreen.
- 1. Touch the kV/mA symbol **(B)** on the right side of the touchscreen.
 - ✦ A submenu line is opened.



- 2. Select a kV/mA value. Touch the - or + keys.
 - ✦ The selected kV/mA value is displayed.
 - 3. Touch the cross on the left side of the submenu line.
- or
- > Touch the kV/mA symbol **(B)** again.
 - ✦ The submenu line is closed.
 - ✦ The kV/mA value is set.

5.1.2.2.6 Positioning the patient

The patient is positioned on the unit while standing. Positioning in the seat is also possible without issue.

CAUTION

The height adjustment motor starts slowly and then increases its speed.

A patient positioned in the unit may be injured by moving parts.

- Monitor the patient and the movement of the unit during height adjustment. To make minor corrections, press and immediately release the keys. Release the button immediately in the event of involuntary contact between patient and device.

CAUTION

Hazard due to laser light.

Patients and users can be blinded by the laser light localizer.

- Prior to activating the laser light localizers, the patient **must** be asked to shut their eyes.
- Do not stare directly into the laser beam. Make sure that the laser beam does not meet the eyes of the patient.
- A distance of at least 10 cm must be maintained between the eye and the laser.

CAUTION

Reduced image quality

The image quality is limited by metal or other radiopaque materials located in the patient's mouth and in its vicinity.

- Ask the patient to take off all metallic objects such as glasses and jewelry in the head and neck area as well as all removable dental prostheses. The tray in front of the control mirror is used for depositing jewelry.

Tip: Reference values are shown for the height and forehead support settings, which are saved for further exposures in the additional information area of the SIDEXIS software.

5.1.2.2.6.1 Positioning for a lateral temporomandibular joint exposure

- ✓ The forehead support and temporomandibular joint supports with ear holders are plugged into the unit (1 right, 2 left, see “Changing the temple supports and temporomandibular joint supports [→ 45]”).
- ✓ The relevant hygienic protective sleeves are pulled over the accessories.

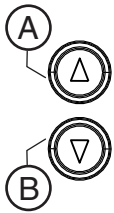
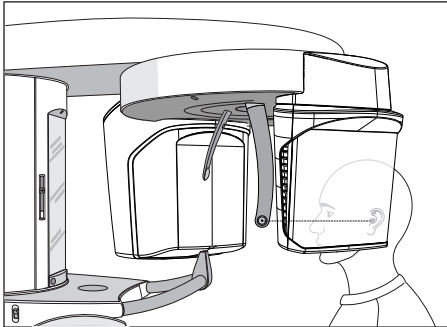

1. Guide the patient in front of the control mirror.

2. Set the unit height using the up (A) and down (B) keys.
CAUTION! The height adjustment motor starts slowly and then increases its speed.
Press and hold down the height adjustment key until the unit has reached the desired height. The unit movement is accompanied by a beep.
Release the height-adjustment buttons once the ear holders of the temporomandibular joint supports are at the same height as that of the patient's ears.

3. Instruct the patient to position himself between the temporomandibular joint supports and hold the handles with both hands.
4. Close the temporomandibular joint supports (J and K). Press the I key.
 - ↪ The temporomandibular joint supports stop automatically when they come into contact with the patient's head. The patient is fixed to the unit by the ear holders.
5. Swivel the control mirror outwards. Press the left recess on the touchbar (D).
 - ↪ You can see the patient in the control mirror.

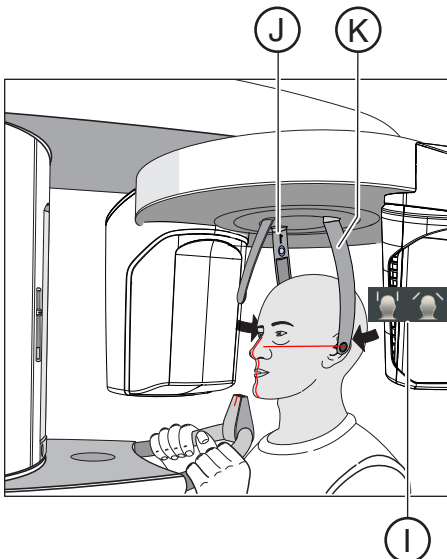

6. Switch on the light localizer. **CAUTION! Risk of dazzle**
 - ↪ Two red laser lines reflect on the patient's head. To switch off the light localizer, press the key again. It switches off automatically after approx. 100 seconds.

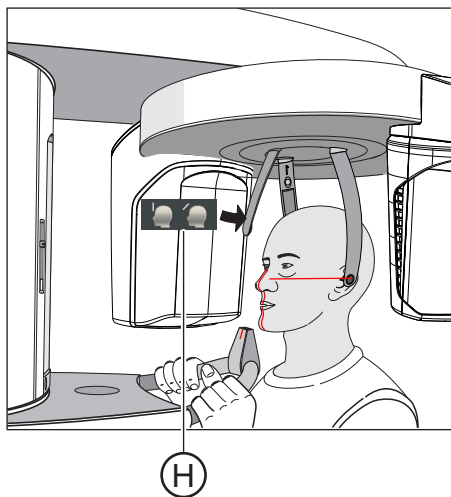
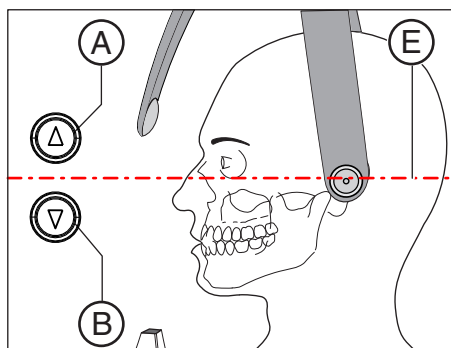
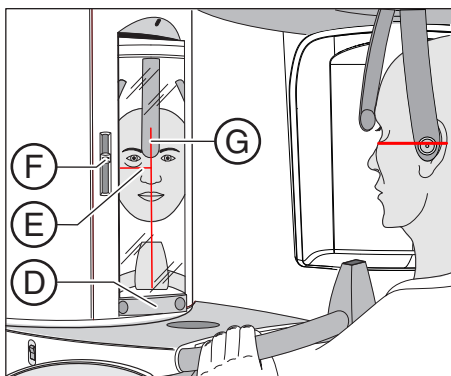

7. Align the patient with the central laser line (G).
 - ↳ The laser line reflects in the center of the patient's anterior teeth or the middle of the face (mid-sagittal).
8. Align the patient's head according to the Frankfurt horizontal plane (E).
9. Adjust the height of the light localizer using the slider (F).
 - ↳ The laser line reflects on the upper edge of the outer ear canal.
10. Correct the patient's head inclination as necessary. Briefly press the up (A) and down (B) height adjustment keys.
 - ↳ The laser line reflects on the lowest point of the lower eye socket edge.
11. Press the forehead support adjustment key (H).
 - ↳ The forehead supports stop moving automatically when they come into contact with the patient's forehead. Ensure that the patient's head does not move backward when the forehead support is put in place.
12. Check the patient's position and make any final corrections as necessary.
13. Swivel the control mirror back into place. by pressing the right recess on the touchbar (D).
 - ↳ The patient can see himself in the control mirror.
14. Instruct the patient to exhale, place his tongue against the roof of his mouth, and hold this position until the end of the exposure.
 - ↳ The patient is positioned in the unit.

IMPORTANT

Note the information on the two-part exposure programs in the "Releasing the exposure" chapter, see "Two-part exposure programs [→ 119]".

5.1.2.3 Sinus view

5.1.2.3.1 Program descriptions

5.1.2.3.1.1 S1 – Paranasal sinuses

This exposure shows the paranasal sinuses e.g. for the diagnosis of orbital floor fractures.

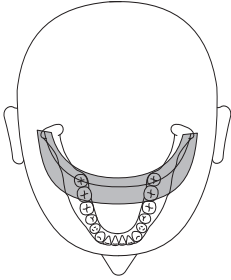

5.1.2.3.1.2 S3 – Paranasal sinuses, linear slice orientation

This exposure shows the paranasal sinuses e.g. for the diagnosis of orbital floor fractures. The section has a linear orientation.

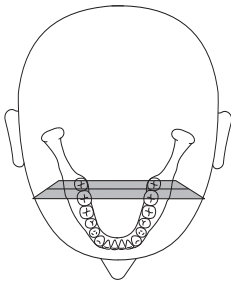

5.1.2.3.2 Preparing the exposure

Depending on the patient or the exposure program, accessory parts must be replaced and the appropriate exposure mode must be selected; see "Installation and start-up" [-> 42].

You will require the following accessories:

- Blue bite block or contact segment
- Temporomandibular joint supports with contact pads
- Forehead support
- > Insert the accessory parts to be used into the unit and pull on the relevant hygienic protective sleeves, see "Hygienic protective sleeves" [-> 39].
- > Switch SIDEXIS to a ready-for-exposure state; see 'Switch SIDEXIS to ready-for-exposure state'.

5.1.2.3.3 Selecting an exposure program

⚠ CAUTION

Pressing the R key moves the unit to the starting position.

A patient positioned in the unit may be injured by moving parts.

- > Check that a patient is not positioned in the unit before moving it to the starting position.

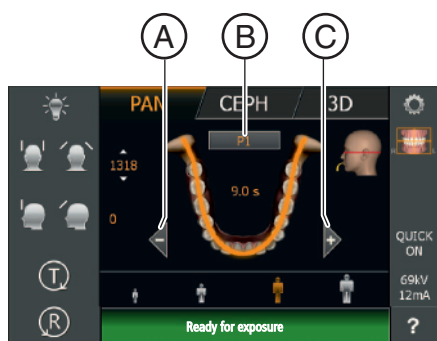

- ✓ The unit is switched on and ready for exposure.
- 1. Touch the PAN symbol at the top of the touchscreen.
 - ↳ The program group PAN is selected.
- 2. Select the exposure program. Press the arrow keys + C and - A.
 - ↳ The exposure program is displayed in the program display (B).
- 3. Follow the instructions in the comment line on the touchscreen. Press the R key if necessary.
 - ↳ The diaphragm and the sensor move into the starting position.
- ↳ The exposure program is selected.

5.1.2.3.4 Setting the kV/mA values

Setting the kV/mA values via the patient symbols

Preset kV/mA combinations are assigned to the patient symbols, which are selected according to the patient's size and weight. The symbols roughly correspond to child, youth/woman, woman/man, hefty persons.

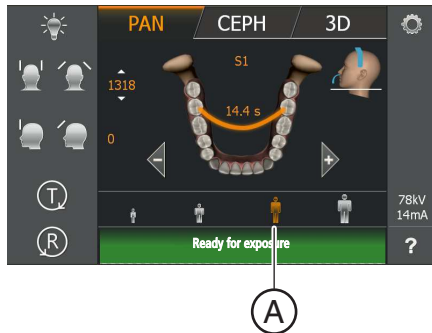

- ✓ Level 1 is displayed on the touchscreen.
- Touch the required patient symbol.
 - ↪ The selection **(A)** is highlighted in orange. The selected kV/mA value is displayed on the right side of the touchscreen.
- ↪ The kV/mA value is set.

Setting the kV/mA values via the submenu line

If the preset kV/mA combinations do not provide a satisfactory result, you can also set the kV/mA values manually in all programs.

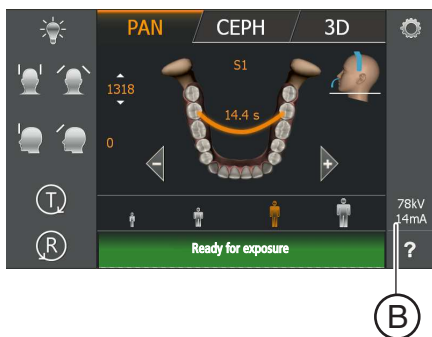

- ✓ Level 1 is displayed on the touchscreen.
- 1. Touch the kV/mA symbol **(B)** on the right side of the touchscreen.
 - ↪ A submenu line is opened.

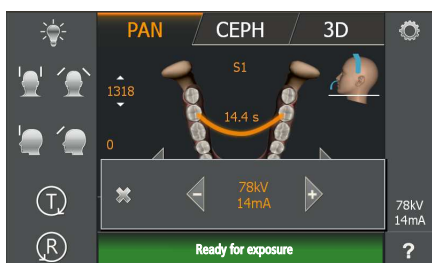

- 2. Select a kV/mA value. Touch the - or + keys.
 - ↪ The selected kV/mA value is displayed.
 - 3. Touch the cross on the left side of the submenu line.
- or
- Touch the kV/mA symbol **(B)** again.
 - ↪ The submenu line is closed.
 - ↪ The kV/mA value is set.

5.1.2.3.5 Positioning the patient

The patient is positioned on the unit while standing. Positioning in the seat is also possible without issue.

CAUTION

The height adjustment motor starts slowly and then increases its speed.

A patient positioned in the unit may be injured by moving parts.

- Monitor the patient and the movement of the unit during height adjustment. To make minor corrections, press and immediately release the keys. Release the button immediately in the event of involuntary contact between patient and device.

CAUTION

Hazard due to laser light.

Patients and users can be blinded by the laser light localizer.

- Prior to activating the laser light localizers, the patient **must** be asked to shut their eyes.
- Do not stare directly into the laser beam. Make sure that the laser beam does not meet the eyes of the patient.
- A distance of at least 10 cm must be maintained between the eye and the laser.

CAUTION

Reduced image quality

The image quality is limited by metal or other radiopaque materials located in the patient's mouth and in its vicinity.

- Ask the patient to take off all metallic objects such as glasses and jewelry in the head and neck area as well as all removable dental prostheses. The tray in front of the control mirror is used for depositing jewelry.

Tip: Reference values are shown for the height and forehead support settings, which are saved for further exposures in the additional information area of the SIDEXIS software.

5.1.2.3.5.1 Positioning for paranasal sinus exposures

- ✓ The blue contact segment and the temporomandibular joint supports with contact pads are inserted into the unit.
- ✓ The relevant hygienic protective sleeves are pulled over the accessories.

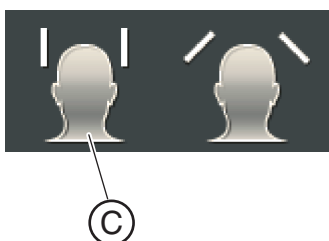
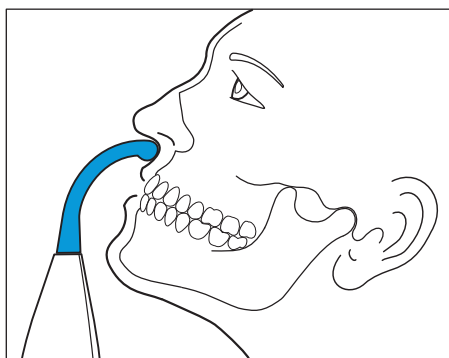
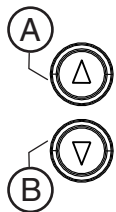
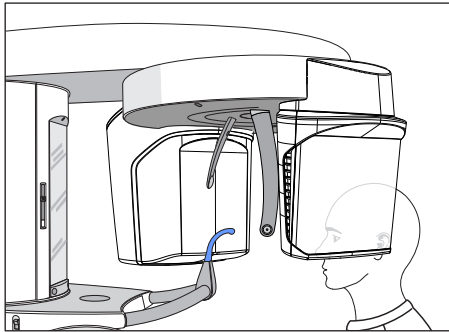

1. Guide the patient in front of the control mirror.
2. Set the unit height using the up (A) and down (B) keys.
CAUTION! The height adjustment motor starts slowly and then increases its speed.
Press and hold down the button until the desired height is reached. The unit movement is accompanied by a beep. Release the height-adjustment buttons once the contact pads of the temporomandibular joint supports are located above the patient's ears.
3. Instruct the patient to position himself between the temporomandibular joint supports and hold the handles with both hands.
4. Instruct the patient to place his subnasale (the base of his nose) against the contact segment and tilt his head backwards as far as possible.
 - ↳ The patient's head is reclined as far as possible.
5. Close the temporomandibular joint supports with the key (C).
 - ↳ The temporomandibular joint supports stop automatically when they come into contact with the patient's head. The patient is fixed to the unit by the contact pads.
6. Check the patient's position and make any final corrections as necessary.
7. Instruct the patient to exhale, place his tongue against the roof of his mouth, and to hold this position until the end of the exposure.
 - ↳ The patient is positioned in the unit.

5.1.2.3.5.2 Positioning for maxillary sinus exposures using the bite block

- ✓ The blue bite block, the forehead support and temple supports are inserted in the unit.
- ✓ The relevant hygienic protective sleeves are pulled over the accessories.

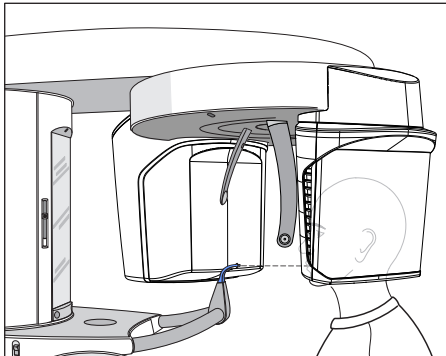

1. Guide the patient in front of the control mirror.

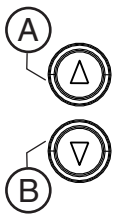

2. Set the unit height using the up **A** and down **B** keys.
CAUTION! The height adjustment motor starts slowly and then increases its speed.
Press and hold down the button until the desired height is reached. The unit movement is accompanied by a beep. Release the height-adjustment buttons once the bite block is at the same height as that of the patient's anterior teeth.
3. Instruct the patient to hold the handles with both hands and bite into the bite block.
 - ↳ The patient's anterior teeth are positioned in the indentation in the bite block. If necessary, push the lower anterior teeth forwards until they reach a stop.
4. Check the patient's occlusal plane **C**. Adjust the unit height using the up (**A**) and down (**B**) keys.
 - ↳ The occlusal plane is slightly inclined toward the front.

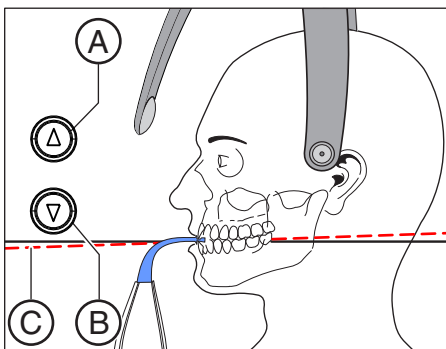

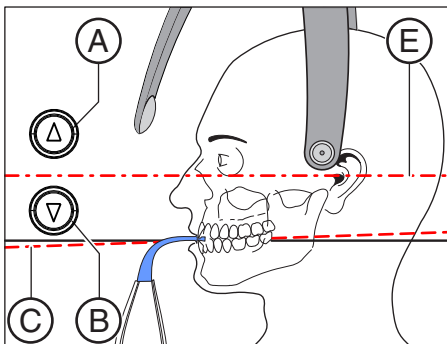
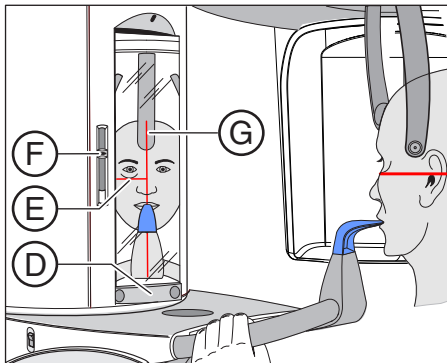
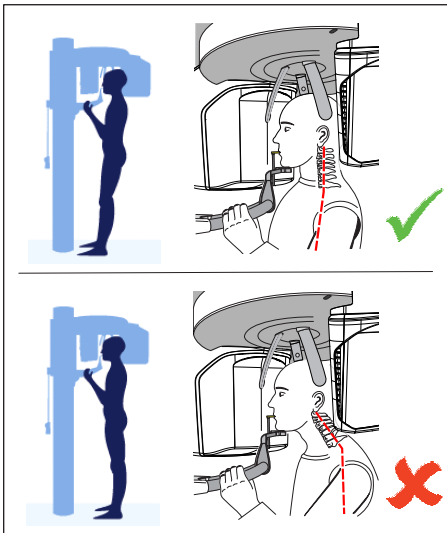

5. Check the position of the patient's spine.
 - ↪ Ensure that the patient's spine is slightly inclined, as shown in the diagram.

Tip: To achieve the correct positioning of the spine, ask the patient to take a small step towards the column of the unit. The patient's cervical vertebrae are thus stretched. This prevents shadowing of the anterior tooth region on the X-ray.
6. Swivel the control mirror outwards. Press the left recess on the touchbar **D**.
 - ↪ You can see the patient in the control mirror.
7. Switch on the light localizer. **CAUTION! Risk of dazzle**
 - ↪ Two red laser lines reflect on the patient's head. To switch off the light localizer, press the key again. It switches off automatically after approx. 100 seconds.
8. Align the patient with the central laser line **G**.
 - ↪ The laser line reflects in the center of the patient's anterior teeth or the middle of the face (mid-sagittal).
9. Align the patient's head according to the Frankfurt horizontal plane (**E**)
10. Adjust the height of the light localizer using the slider **F**.
 - ↪ The laser line reflects on the upper edge of the outer ear canal.
11. Correct the patient's head inclination as necessary. Briefly press the up **A** and down **B** height adjustment keys.
 - ↪ The laser line reflects on the lowest point of the lower eye socket edge.

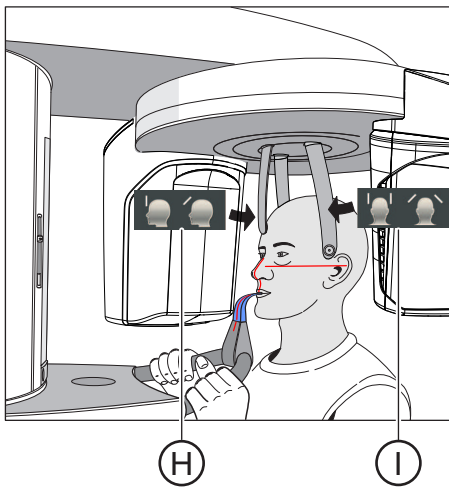

12. Press the temple support adjustment button **(I)**.
 - ↳ When you touch the patient's head, the temple supports stop automatically.
13. Press the forehead support adjustment key **(H)**.
 - ↳ When you touch the patient's head, the forehead support stops automatically.
Make sure that the patient's head does not move backwards when placing the forehead support.
14. Check the patient's position and make any final corrections as necessary.
15. Swivel the control mirror back into place. Press the right recess on the touchbar **D**.
 - ↳ The patient can see himself in the control mirror.
16. Instruct the patient to exhale, place his tongue against the roof of his mouth, and hold this position until the end of the exposure.
 - ↳ The patient is positioned in the unit.

5.1.2.3.5.3 Positioning for maxillary sinus exposures using the contact segment

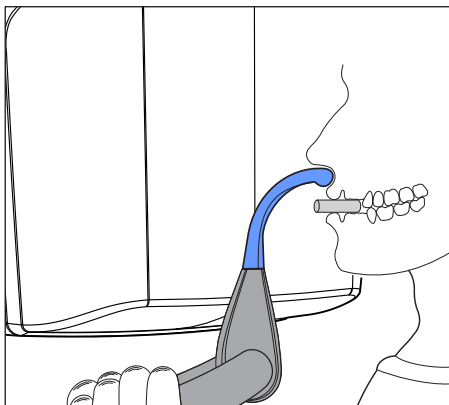

- ✓ The patient has no or only a few anterior teeth.
 - ✓ The blue contact segment is inserted in the unit.
 - ✓ The relevant hygienic protective sleeves are pulled over the accessories.
1. Instruct the patient to hold the handles with both hands and place his subnasale (the base of his nose) against the contact segment.
 2. Place a cotton roll between the patient's upper and lower jaw.
 - ↳ The patient's upper and lower jaw are aligned.
 3. Proceed as described under "Positioning for maxillary sinus exposures using the bite block [→ 80]" from step 4.

5.1.2.4 Volume exposures

5.1.2.4.1 Program description

If the panoramic X-ray unit is equipped with a 3D function unit, volume exposures can be prepared using cone-beam technology. This enables the diagnosis of section images at the axial, sagittal, and coronal level.

The Low Dose mode in programs VOL1, VOL2 und VOL3 is not available in every country.

5.1.2.4.1.1 VOL1 HD / VOL1 SD / VOL1 Low

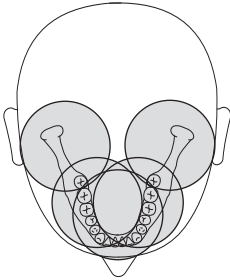

The Easypad can be used to select one of the five volume regions:

- Anterior tooth region
- Right/left molar region
- Right/left temporomandibular joint area

The volume range on the object / field of view (FoV) corresponds to a cylinder with a diameter of approx. 8 cm and a height of approx. 8 cm. For dose reduction, the volume for upper/lower jaw exposures can be collimated to approx. 5.5cm.

SD mode (standard definition mode):

Standard mode for producing a volume exposure

HD mode (High Definition mode):

Four times more single projections are generated in HD mode than in SD mode that can be used for finer reconstructed image quality. This can reduce typical DVT/conebeam artifacts.

Please be aware of the maximum patient dose.

Low Dose mode:

The effective dose for the patient is reduced significantly in Low Dose mode.

VOL1 (8x8 cm)

Please note that blurring can occur in the marginal area of the cylinder. Objects are nevertheless represented in the maximum possible image quality.

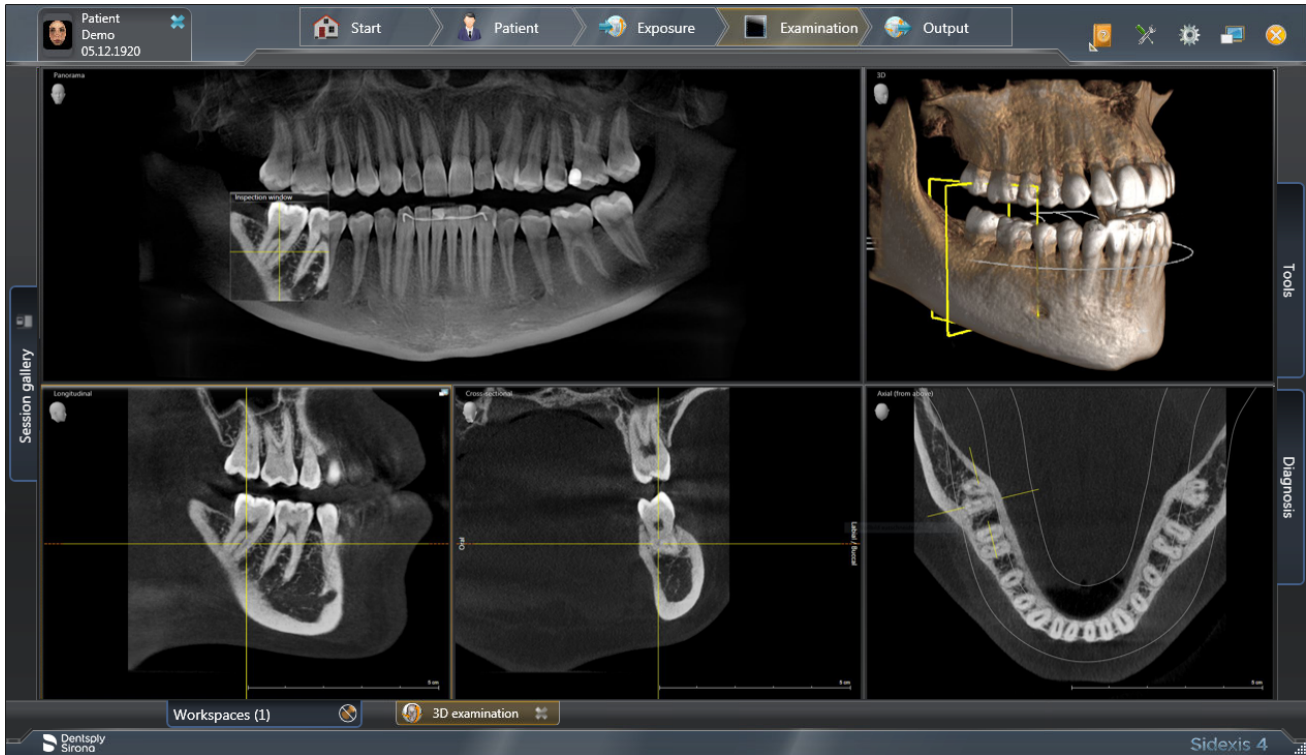

5.1.2.4.1.2 VOL2 HD / VOL2 SD / VOL2 Low

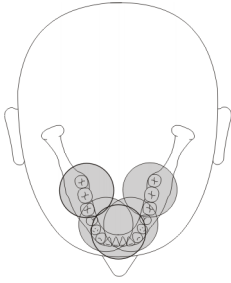

The EasyPad can be used to select one of the five volume regions:

- Upper jaw / lower jaw anterior tooth region
- Premolar or molar region to the left/right, up/down

The volume range on the object / field of view (FoV) corresponds to a cylinder with a diameter of approx. 5 cm and a height of approx. 5.5 cm. A smaller volume reduces the patient dose.

SD mode (standard definition mode):

Standard mode for producing a volume exposure

HD mode (High Definition mode):

Four times more single projections are generated in HD mode than in SD mode that can be used for finer reconstructed image quality. This can reduce typical DVT/conebeam artifacts.

HD mode offers a voxel resolution of 80µm for VOL2.

Please be aware of the higher patient dose.

Low Dose mode:

The effective dose for the patient is reduced significantly in Low Dose mode.

VOL2 (5x5.5 cm)

Please note that blurring can occur in the marginal area of the cylinder. Objects are nevertheless represented in the maximum possible image quality.

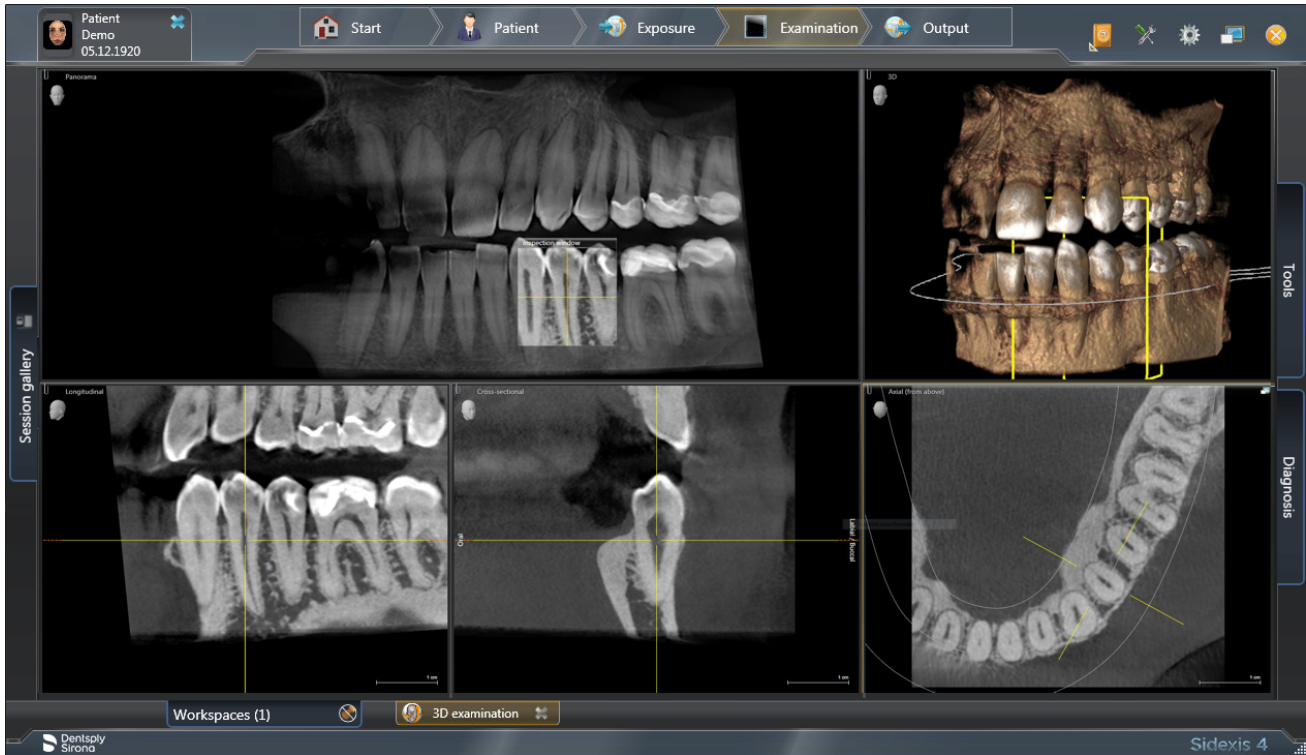

5.1.2.4.1.3 Option: VOL3 HD / VOL3 SD / VOL3 Low

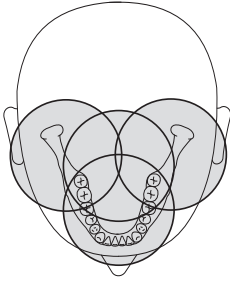

The Easypad can be used to select one of the 4 volume regions:

- Anterior tooth region
- Molar region without anterior teeth
- Temporomandibular joint area with molars right/left

The volume range on the object / field of view (FoV) corresponds to a cylinder with a diameter of approx. 11 cm and a height of approx. 10 cm. For dose reduction, the volume can be collimated for exposures of the upper jaw to approximately 7.5 cm to about 8.0 cm by selecting the lower quadrants.

SD mode (standard definition mode):

Standard mode for producing a volume exposure.

HD mode (High Definition mode):

Four times more single projections are generated in HD mode than in SD mode that can be used for finer reconstructed image quality. This can reduce typical DVT/conebeam artifacts.

Please be aware of the maximum patient dose.

Low Dose mode:

The effective dose for the patient is reduced significantly in Low Dose mode.

VOL3 (11x10cm)

Please note that blurring can occur in the marginal area of the cylinder. Objects are nevertheless represented in the maximum possible image quality.

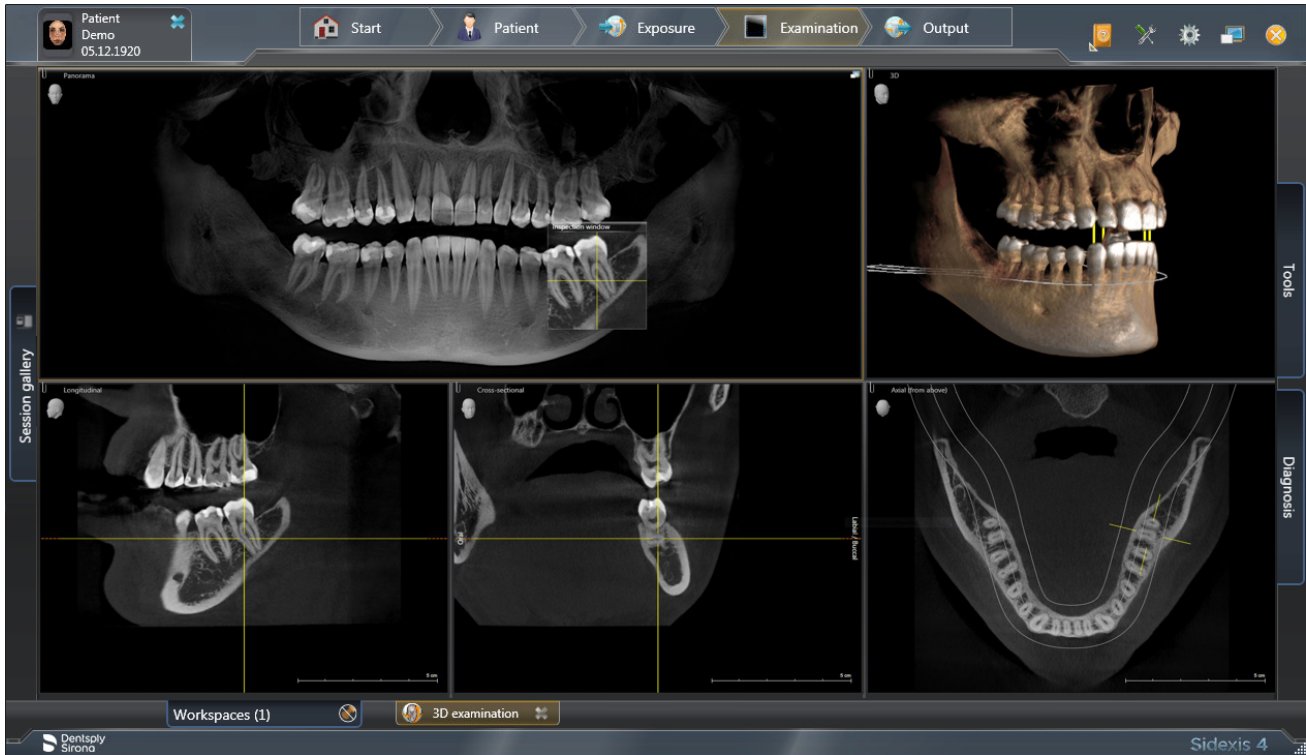

5.1.2.4.1.4 Low Dose exposure mode for VOL1 Low, VOL2 Low und VOL3 Low

The Low Dose exposure mode can be selected for all volume levels (VOL1, VOL2, VOL3 (optional)) and collimations.

The only exclusions are the centers of rotation for temporomandibular joint exposures for the volume ranges VOL1 and VOL3 (the setting for the volume ranges and the collimation can be found in the chapter "Adjusting the volume area and collimation [→ 92]").

Low Dose mode:

The effective dose for the patient is reduced significantly in Low Dose mode.

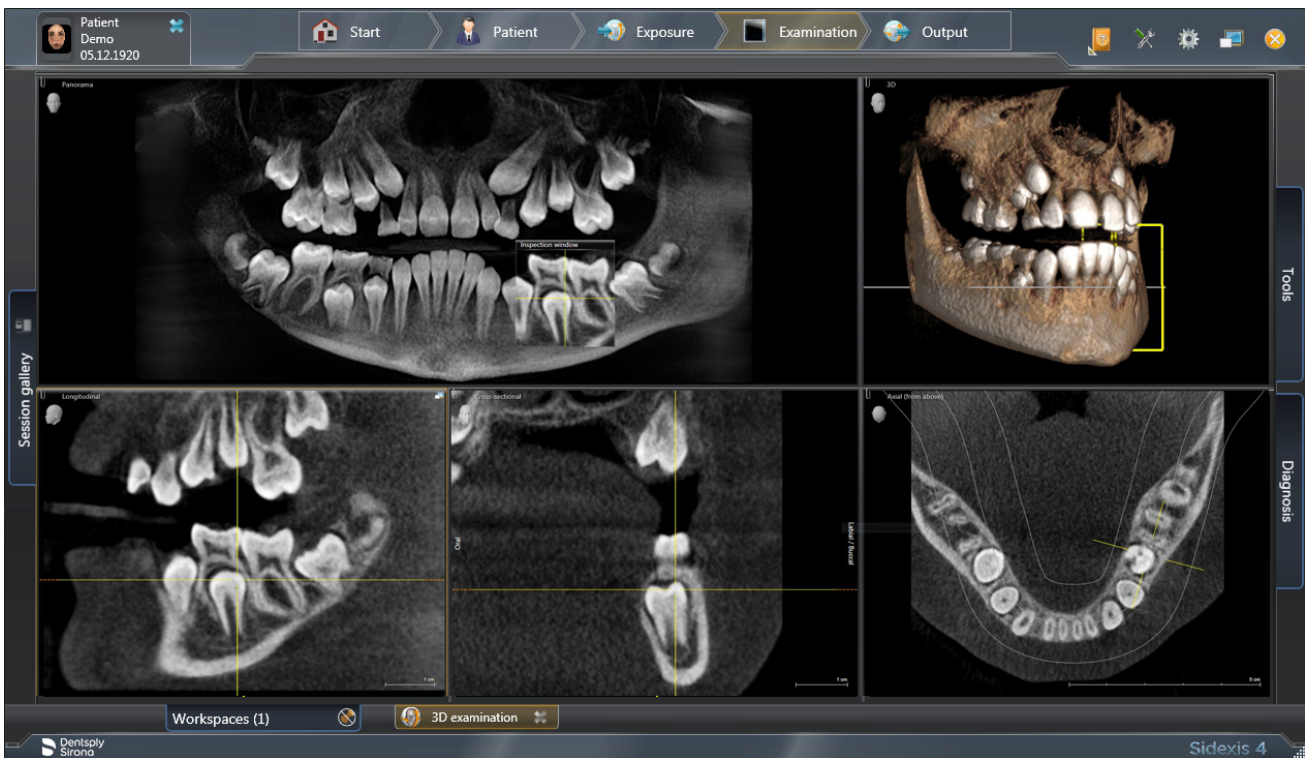

5.1.2.4.2 Preparing the exposure

You will need to replace accessory parts according to the patient or exposure program.

In general, exposures of all volume areas can be made with the 3D bite block, the yellow bite block or the universal bite block. The 3D bite block or universal bite block is recommended for volume exposures. If it is not possible to work with these bite blocks, another possibility is to use the chin rest with the bite block rod or bar.

While positioning the patient, the upper and lower volume limit is shown with the light localizer on the patient's head. If it then becomes apparent that the desired exposure area is located outside of the limits of the light localizer, the patient's head can be positioned lower or higher in the beam path by using a different bite block.

If exposures are to be taken in the maxillary, temporomandibular, sinus and orbital regions, the patient can then be positioned lower accordingly with the blue bite block or the universal bite block in several layers. The proportional volume in the sinus region is thus greater.

Positioning is also possible with the universal bite block, as this can be adjusted in several stages and the wide, soft bite block foam offers increased safety against vibrations. The bite block foam is equally suitable for patients without anterior teeth.

Positioning is also possible with the occlusal bite block. The occlusal bite block sets the inclination according to the occlusal plane instead of the Frankfurt horizontal plane.

Two spherical bite blocks are available for preparing an implant drilling template for measuring scans of the upper or lower jaw. The bite block plates can be ordered from the SICAT Online Shop, www.sicat.com.

The following accessories are also required:

- Temple supports or temporomandibular joint supports with contact pads
- Forehead support
- > Insert the accessory parts to be used into the unit and pull on the relevant hygienic protective sleeves, see "Hygienic protective sleeves" [→ 39].
- > Switch SIDEXIS to a ready-for-3D-exposure state; see 'Switch SIDEXIS to ready-for-exposure state'.

5.1.2.4.3 Selecting the volume exposure

⚠ CAUTION

Pressing the R key moves the unit to the starting position.

A patient positioned in the unit may be injured by moving parts.

- Check that a patient is not positioned in the unit before moving it to the starting position.

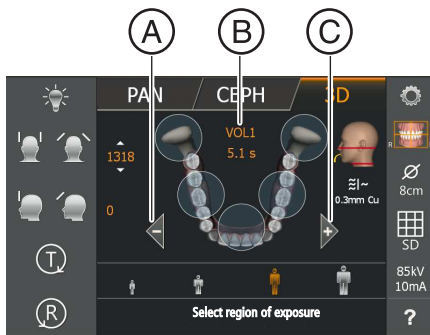

- ✓ The unit is switched on and ready for exposure.
- 1. Touch the 3D symbol at the top of the touchscreen.
 - ↳ The 3D program group is selected.
- 2. Select the exposure program. Press the arrow keys + C and - A.
 - ↳ The exposure program is displayed in the program display (B). The radiation time is displayed under the name of the exposure program.
- 3. Follow the instructions in the comment line on the touchscreen. Press the R key if necessary.
 - ↳ The diaphragm and the sensor move into the starting position for volume exposures.
- ↳ The exposure program is selected.
- ↳ In volume exposures, the total filtration of the X-ray tube assembly is displayed below the head symbol on the touchscreen. It corresponds with 0.3 mm Cu in SD and HD modes, and to 1mm Cu in Low mode.

5.1.2.4.4 Adjusting the volume area and collimation

You can change between VOL1, VOL2, and VOL3 (optionally) depending on whether a smaller or larger volume can be used. For volume exposures one of the predefined volume areas must be selected. By selecting the quadrants, collimation of the volume in VOL1 program can be set to a height of 5.5 cm for the upper or lower jaw area, while in VOL2 program, the height is permanently set to 5.5 cm and in VOL3 program, collimation of the volume can be set to a height of 7.5 cm for the upper jaw and 8.0 cm for the lower jaw. However, you must always select a quadrant; or, for the front upper jaw teeth or front lower jaw teeth, the upper or lower area must be selected.

IMPORTANT

The regions shown do not correspond to the actual diameter of the volume on the touchscreen. See the figure in the section "VOL1 – Program description".

- ✓ Level 1 is displayed on the touchscreen.
- ✓ The message "H403 – Switch SIDEXIS to ready for exposure state" appears in the comment line.

1. Select the desired volume area **A**. Touch one of the circles for the anterior, molar, or temporomandibular joint area (only VOL1, VOL3) in the center of the touchscreen.

↳ The selected volume area is highlighted orange. According to your selection, the quadrant selection presetting **B** changes if necessary:
VOL1, VOL3: The quadrant selection can be used for volume collimation. Selecting the molar or temporomandibular joint region, for example, sets collimation for the upper or lower jaw region.

2. Press the quadrant symbol **B** on the right side of the touchscreen.
↳ A submenu line is opened.

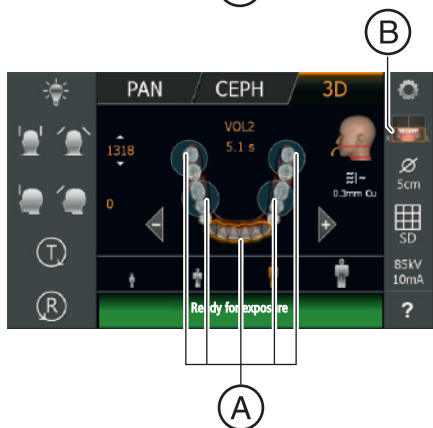
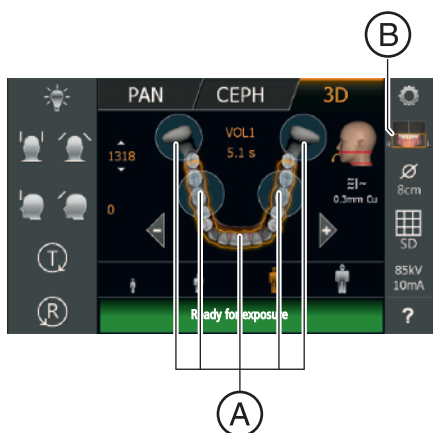

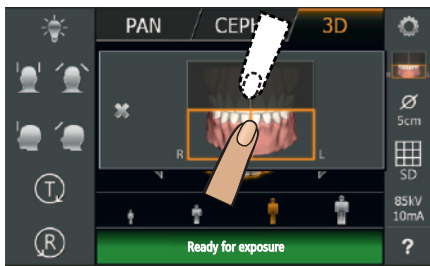

3. To adjust the collimation, select the lower or upper jaw in the quadrant selection.
 - ↳ The selection is highlighted in orange.
4. Touch the cross on the left side of the submenu line.
 - or
 - > Touch the quadrant symbol **B** again.
 - ↳ The submenu line is closed.
 - ↳ The volume area is selected.
 - VOL1, VOL3: The collimation is set.

5.1.2.4.5 Selecting 3D exposure mode

HD mode (high-definition mode).

SD mode (standard definition mode)

Low (Low Dose exposure mode)

You can select the exposure mode via the selection list on the side for the volume programs.



(A)

- ✓ Level 1 is displayed on the touchscreen.
- > Touch the desired exposure mode.

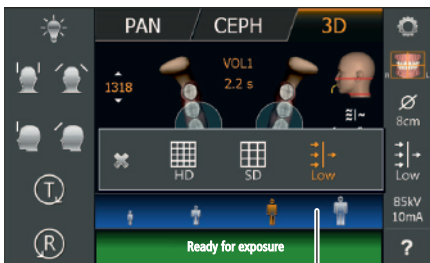

(B)

- ↳ The selection **(A)** is highlighted in orange. The selected mode is displayed on the right side of the touchscreen.
 - If Low Dose mode is enabled the patient symbols are highlighted with a blue bar **B**.
- ↳ The desired mode is selected.
 - The SD and HD options can also be set in the Start settings menu by default.

IMPORTANT

The Low Dose mode is not persistent and must be selected again following each exposure if required.

5.1.2.4.6 Selecting kV/mA values

85 kV are usually emitted for volume exposures. Preset kV/mA combinations and radiation times are assigned to the patient symbols, which are selected according to the patient's size and weight. The symbols roughly correspond to child, youth/woman, woman/man, hefty persons. The kV/mA values and radiation times are preset, see also "Program values for volume exposures".

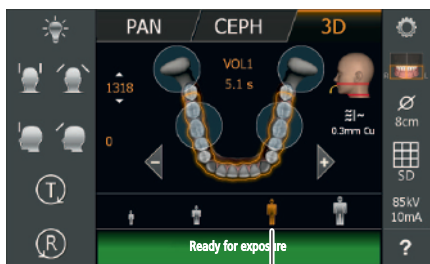

- ✓ Level 1 is displayed on the touchscreen.
- Touch the required patient symbol.
 - ✎ The selection **(A)** is highlighted in orange. The selected kV/mA value is displayed on the right side of the touchscreen and the radiation time is shown below the program name.
- ✎ The kV/mA value is selected.

In HD exposure mode: Setting the kV/mA values via the submenu line

If the preset kV/mA combinations do not provide a satisfactory result via the patient symbols, you can also set the kV/mA values manually in all programs in HD exposure mode.



- ✓ Level 1 is displayed on the touchscreen.
- 1. Touch the kV/mA symbol **(B)** on the right side of the touchscreen.
 - ✎ A submenu line is opened.
- 2. Select a kV/mA value. To do this, touch the arrow keys - or +. Please be aware of the maximum patient dose.
 - ✎ The selected kV/mA value is displayed.

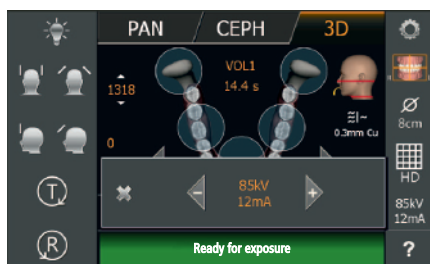

- 3. Touch the cross on the left side of the submenu line.
- or
- Touch the kV/mA symbol **(B)** again.
 - ✎ The submenu line is closed.
- ✎ The kV/mA value is set.

5.1.2.4.7 Positioning the patient

The patient is positioned on the unit while standing. Positioning in the seat is also possible without issue.

CAUTION

The height adjustment motor starts slowly and then increases its speed.

A patient positioned in the unit may be injured by moving parts.

- Monitor the patient and the movement of the unit during height adjustment. To make minor corrections, press and immediately release the keys. Release the button immediately in the event of involuntary contact between patient and device.

CAUTION

Hazard due to laser light.

Patients and users can be blinded by the laser light localizer.

- Prior to activating the laser light localizers, the patient **must** be asked to shut their eyes.
- Do not stare directly into the laser beam. Make sure that the laser beam does not meet the eyes of the patient.
- A distance of at least 10 cm must be maintained between the eye and the laser.

CAUTION

Reduced image quality

The image quality is limited by metal or other radiopaque materials located in the patient's mouth and in its vicinity.

- Ask the patient to take off all metallic objects such as glasses and jewelry in the head and neck area as well as all removable dental prostheses. The tray in front of the control mirror is used for depositing jewelry.

Tip: Reference values are shown for the height and forehead support settings, which are saved for further exposures in the additional information area of the SIDEXIS software.

In volume exposures, 2 red laser lines are emitted after switching on the light localizer. The laser lines show the upper and lower volume limit depending on the program and collimation.

2 red lines are displayed in the head symbol on the touchscreen. They indicate the limit of the volume at the bottom and at the top, and the approximate position of the light beam.

The patient should be aligned in accordance with the occlusal plane. The position can be easily corrected via the head inclination.

5.1.2.4.7.1 Positioning with 3D bite block or universal bite block

In general, exposures of all volume areas can be made with the 3D bite block, the yellow bite block or the universal bite block. The 3D bite block or the universal bite block is recommended for volume exposures, as the patient is positioned more securely. If it is not possible to work with these bite blocks, another possibility is to use the chin rest with the bite block rod or bar, see "Positioning with chin rest [→ 98]". The foam of the universal bite block is equally suitable for patients without anterior teeth.

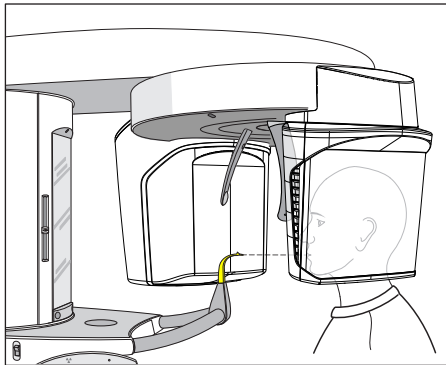

- ✓ The 3d bite block, the yellow bite block, the universal bite block and forehead support and temple supports are inserted in the unit.
 - ✓ The relevant hygienic protective sleeves are pulled over the accessories.
1. Guide the patient in front of the control mirror.

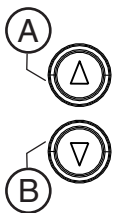

2. Set the unit height using the up **A** and down **B** keys.
CAUTION! The height adjustment motor starts slowly and then increases its speed.
Press and hold down the button until the desired height is reached. The unit movement is accompanied by a beep. Release the height adjustment buttons once the patient's mouth and the bite block are at the same height.
3. Instruct the patient to hold the handles with both hands and bite into the bite block.
 - ↳ The patient's anterior teeth are positioned in the indentation in the bite block. If necessary, push the lower anterior teeth forwards until they reach a stop.

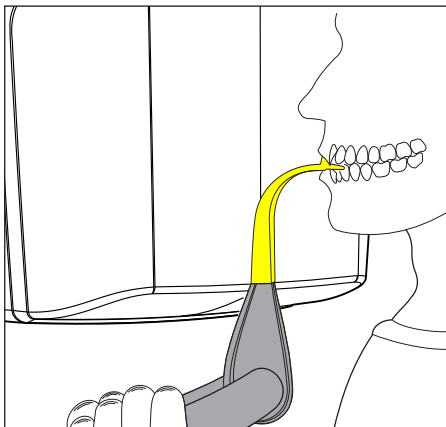

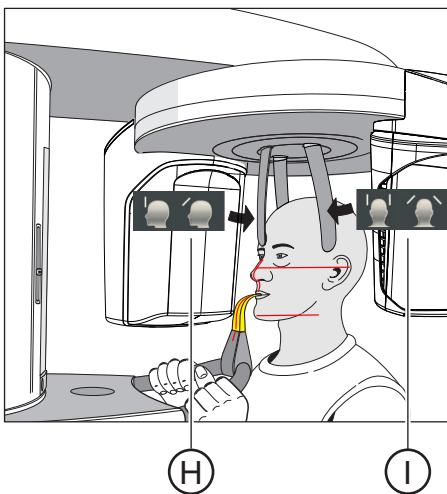
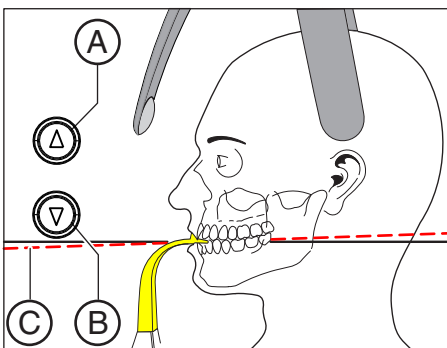
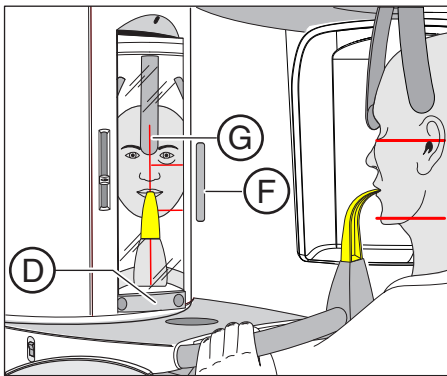

4. Swivel the control mirror outwards. Press the left recess on the touchbar **D**.
 - ↳ You can see the patient in the control mirror.
 5. Switch on the light localizer **F**.

CAUTION! Risk of dazzle

 - ↳ Depending on a preselected program and collimation, the laser lines show the upper and lower edges of the volume on the patient's head. If the desired exposure area is not located within the horizontal laser lines, the blue bite block or the universal bite block must be used, see "Positioning with blue bite block or the universal bite block. [→ 99]".
 - To switch off the light localizer, press the key again. It switches off automatically after approx. 100 seconds.
 6. Align the patient with the central laser line **G**.
 - ↳ The laser line reflects in the center of the patient's anterior teeth or the middle of his face (mid-sagittal).
 7. Align the patient's head as closely as possible along the occlusal plane (**C**). Correct the patient's head inclination as necessary. Briefly press the up **A** and down **B** height adjustment keys.
 8. Press the temple support adjustment button **I**.
 - ↳ When you touch the patient's head, the temple supports stop automatically.
 9. Press the forehead support adjustment key (**H**).
 - ↳ When you touch the patient's head, the forehead support stops automatically.
 - Make sure that the patient's head does not move backwards when placing the forehead support.
 10. Check the patient's position and make any final corrections as necessary.
 11. Swivel the control mirror back into place. Press the right recess on the touchbar **D**.
 - ↳ The patient can see himself in the control mirror.
 12. Instruct the patient to exhale, place his tongue against the roof of his mouth, and hold this position until the end of the exposure.
 - ↳ The patient is positioned in the unit.
- Tip:** You can limit the volume by selecting individual segments using the quadrant selection, see "Adjusting the volume area and collimation [→ 92]".

5.1.2.4.7.2 Positioning with chin rest

If it is not possible to work with the 3D bite block or the yellow bite block, it is possible to use the chin rest instead. Patients without anterior teeth also can be positioned with the bar.

The chin rest can be used to ensure that the mandible is represented in the volume.

Chin rest with bite block rod

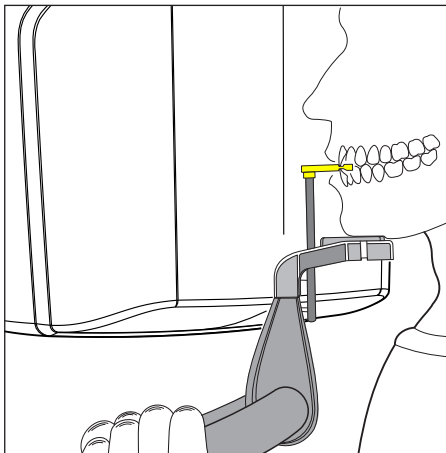

- ✓ The chin rest and bite block rod, and the forehead support and temple supports are inserted in the unit.
- ✓ The relevant hygienic protective sleeves are pulled over the accessories.
- 1. Turn the bite block away from the patient.
 - ↳ The bite block is pointing towards the control mirror.
- 2. Instruct the patient to place his chin on the chin rest and place both hands on the hand grips.
- 3. Turn the bite block towards the patient and instruct him to bite on the bite block.
 - ↳ The patient's anterior teeth are positioned in the indentation in the bite block. If necessary, push the lower anterior teeth forwards until they reach a stop.
- 4. Proceed from step 4 as described under "Positioning with 3D bite block or universal bite block [→ 96]".

Chin rest with bar

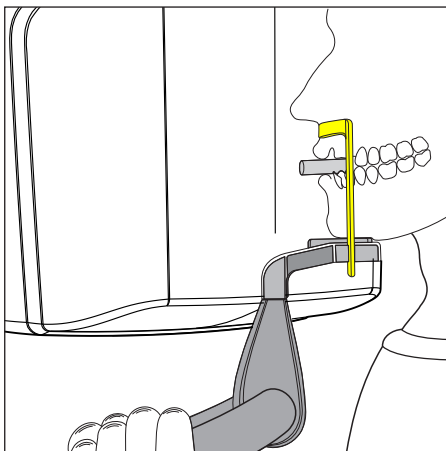

- ✓ The patient has no or only a few anterior teeth.
- ✓ The chin rest and bar and the forehead support and temple supports are inserted in the unit.
- ✓ The relevant hygienic protective sleeves are pulled over the accessories.
- 1. Instruct the patient to place his chin on the chin rest and place both hands on the hand grips.
- 2. Instruct the patient to place his subnasale (the base of his nose) against the bar. The patient's upper and lower jaws must be aligned above one another. If the patient's lower jaw contains anterior teeth, place the bar between his chin and his lower lip.
- 3. Proceed from step 4 as described under "Positioning with 3D bite block or universal bite block [→ 96]".

5.1.2.4.7.3 Positioning with blue bite block or the universal bite block.

For maxillary exposures with the full volume, the patient should be positioned lower with the blue bite block or universal bite block in the position marked blue; this also applies to exposures taken in the temporomandibular, sinus and orbital regions. The proportional volume in the sinus region is thus greater.

More secure positioning is possible with the universal bite block due to the wider bite area. The bite block foam is equally suitable for patients without anterior teeth.

- ✓ The blue bite block or the universal bite block and the temporomandibular joint supports with contact pads are inserted into the unit.
- ✓ The relevant hygienic protective sleeves are pulled over the accessories.

1. Guide the patient in front of the control mirror.

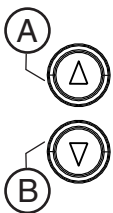
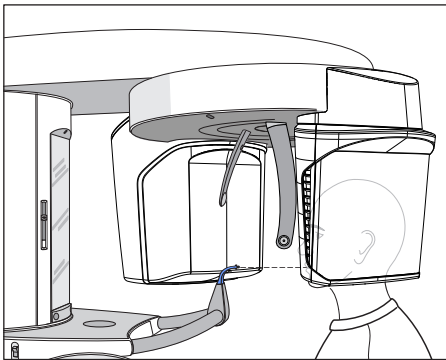

2. Set the unit height using the up **A** and down **B** keys.

CAUTION! The height adjustment motor starts slowly and then increases its speed.

Press and hold down the button until the desired height is reached.

The unit movement is accompanied by a beep.

Release the height-adjustment buttons once the bite block is at the same height as that of the patient's anterior teeth.

3. Instruct the patient to hold the handles with both hands and bite into the bite block.

↳ The patient's anterior teeth are positioned in the indentation in the bite block. If necessary, push the lower anterior teeth forwards until they reach a stop.

4. Swivel the control mirror outwards. Press the left recess on the touchbar **D**.

↳ You can see the patient in the control mirror.

5. Switch on the light localizer **F**.

CAUTION! Risk of dazzle

↳ Depending on a preselected program and collimation, the laser lines show the upper and lower edges of the volume on the patient's head. The desired exposure area must be located between the two horizontal laser lines.

To switch off the light localizer, press the key again. It switches off automatically after approx. 100 seconds.

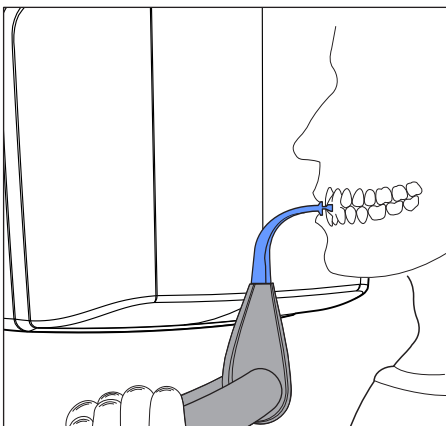

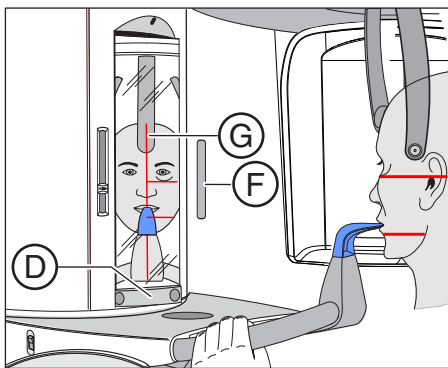

6. Align the patient with the central laser line **G**.
 ↪ The laser line reflects in the center of the patient's anterior teeth or the middle of his face (mid-sagittal).

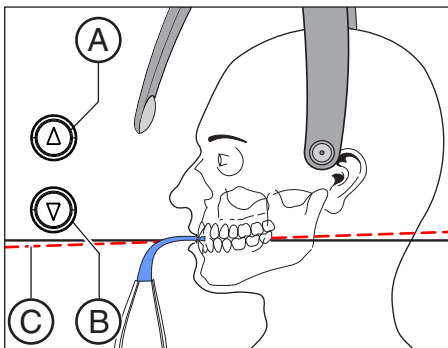

7. Align the patient's head as closely as possible along the occlusal plane (**C**). Correct the patient's head inclination as necessary. Briefly press the up **A** and down **B** height adjustment keys.

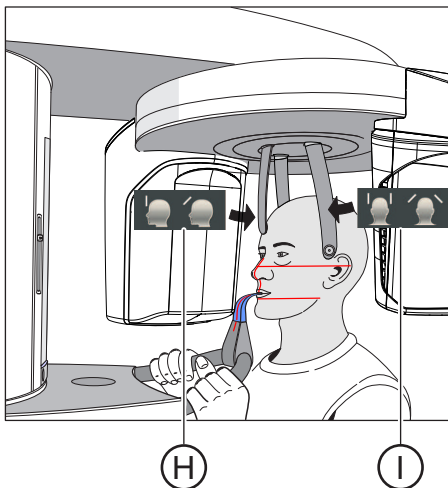

8. Press the temple support adjustment button **I**.
 ↪ When you touch the patient's head, the temple supports stop automatically.
9. Press the forehead support adjustment key (**H**).
 ↪ When you touch the patient's head, the forehead support stops automatically.
 Make sure that the patient's head does not move backwards when placing the forehead support.
10. Check the patient's position and make any final corrections as necessary.
11. Swivel the control mirror back into place. Press the right recess on the touchbar **D**.
 ↪ The patient can see himself in the control mirror.
12. Instruct the patient to exhale, place his tongue against the roof of his mouth, and hold this position until the end of the exposure.
 ↪ The patient is positioned in the unit.

5.1.2.5 Cephalometric exposures

5.1.2.5.1 Program description

Be aware of the different viewing directions in medical and dental radiology.

5.1.2.5.1.1 C1 – Posterior-anterior exposure, symmetrical

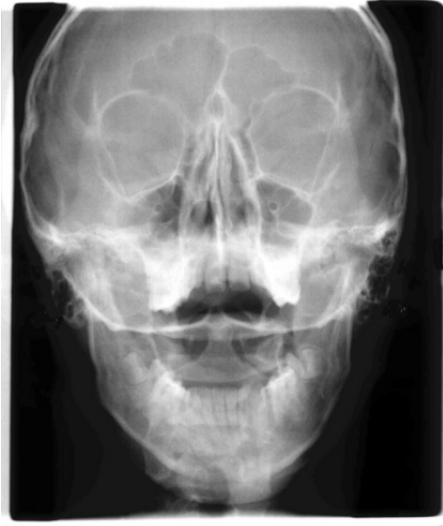

The program takes a full-format exposure from posterior to anterior. This program is suitable only for semi-axial cranial exposures. The exposure provides a cranio-eccentric overview.

5.1.2.5.1.2 C2 – Anterior - posterior exposure, symmetrical

The program takes a full-format exposure from anterior to posterior. This program is suitable only for semi-axial cranial exposures. The exposure provides a cranio-eccentric overview.

5.1.2.5.1.3 C3 – Lateral exposure

With this exposure technique, a metal scale integrated in the nose support is displayed on the X-ray exposure. Using this scale, the magnification factor in the median plane can be determined precisely via a measurement.

C3 - Lateral exposure, asymmetric

This program displays a full-format lateral view (approx. 18x23cm). This program omits the front of the patient's head.



C3F - Lateral full-format exposure

This program displays a full-format lateral view (approx. 30x23cm). This program displays the whole of the patient's head.

Tip: By default, the image of the lateral exposure C3 or C3F shows the patient's face facing to the right. You can change this representation in SIDEXIS. "*Settings*" - "*General Settings*" - Representation - "*Ceph a.p./p.a.*"

Please note that all other Ceph exposures C1, C2, and C4 will then also be displayed 'mirrored', i.e. laterally reversed.



5.1.2.5.1.4 C4 – Carpus view, symmetrical



The program displays a carpus view. The carpus view is used to determine the growth stage of the body or the jaw.

5.1.2.5.2 Preparing the exposure

NOTE

The adjustment of the cephalometer may alter depending on the load.

A change in the adjustment may lead to faulty X-rays.

- > Never lean against the cephalometer or the extension arm.
- > Do not hang or place any objects against or on the cephalometer or extension arm.

Depending on the patient or the exposure program, accessory parts must be replaced and the appropriate exposure mode must be selected; see "Installation and start-up" [→ 42].

The following illustrations of the cephalometer are shown in the left-handed arm version. They also apply for the cephalometer with a right-handed arm.

A = asymmetrical
S = symmetrical

Preparing the nose support

1. Grasp the nose support at the rotary joint.
2. Pull the nose support forwards until it reaches the stop.
3. Swivel the nose support sideways and upwards.

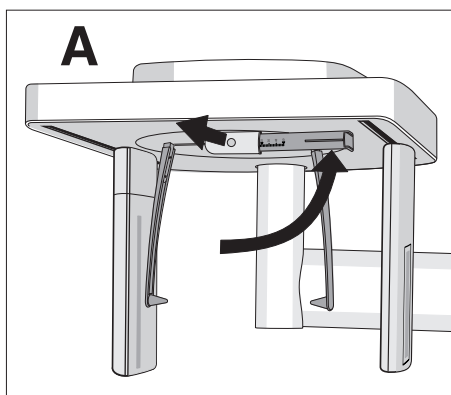

Move the ear plug holders

1. Grasp the holders at the very top with both hands.
2. Push the holders simultaneously outwards as far as they will go.

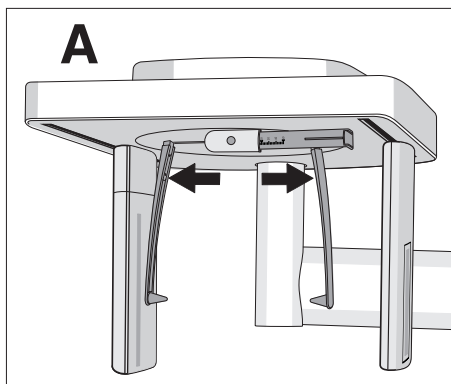

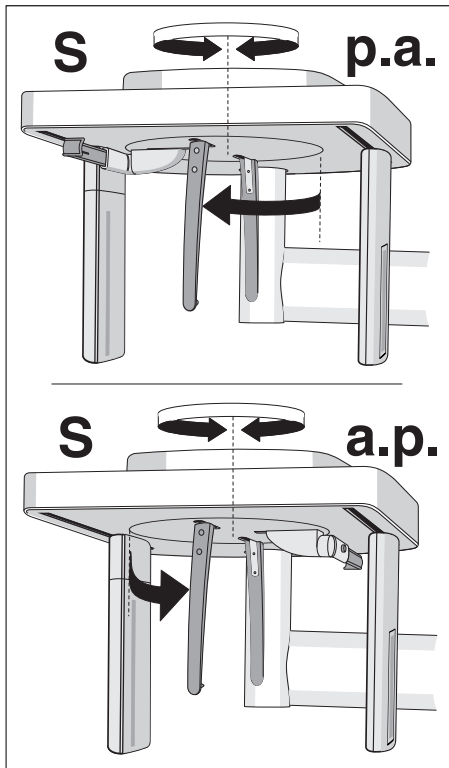

Turn the ear plug holders

Note that the holder for the ear plugs must be rotated by 90 degrees for symmetrical exposures and carpus exposures.

1. Grasp the holders at the very top with both hands.
2. Rotate the ear plug holders.
 - ↳ In posterior-anterior exposure: The nose support points towards the sensor. In posterior-anterior exposure and carpal exposures: The nose support points towards the secondary diaphragm.

Protective caps and hygienic protective sleeves

- > Plug the protective caps onto the ear plugs and pull the hygienic protective sleeve onto the nose support, see "Hygienic protective sleeves" [→ 39].

Preparing for a 2D exposure

- > Switch SIDEXIS to a ready-for-exposure state; see 'Switch SIDEXIS to ready-for-exposure state'.

5.1.2.5.3 Selecting an exposure program

⚠ CAUTION

Pressing the R key moves the unit to the starting position.

A patient positioned in the unit may be injured by moving parts.

- Check that a patient is not positioned in the unit before moving it to the starting position.

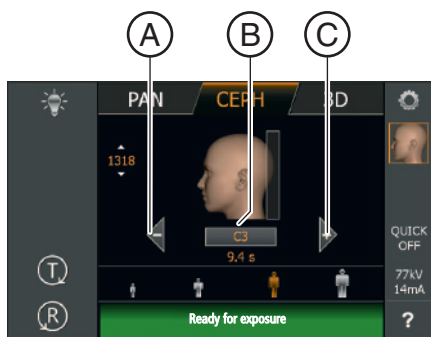

- ✓ The unit is switched on and ready for exposure.
- 1. Touch the CEPH symbol at the top of the touchscreen.
 - ↳ The CEPH program group is selected.
- 2. Select an exposure program. To do this, touch the arrow keys + **C** and - **A**. If you want to select a subprogram, such as C3F, touch the program display **B** repeatedly. All the subprograms in the selected program are displayed one after the other.
- 3. Follow the instructions in the comment line on the touchscreen. Press the R key if necessary.
 - ↳ The diaphragm and the sensor move into the starting position for cephalometric exposures.
 - ↳ The exposure program is selected.

5.1.2.5.4 Adjusting the collimation

In programs C3, C3 F, C1 p.a. and C2 a.p, the exposure area can be limited so that certain parts of the patient's head, e.g. the upper cranial region, thyroid gland and posterior cranial region, are not irradiated. This reduces the patient dose.

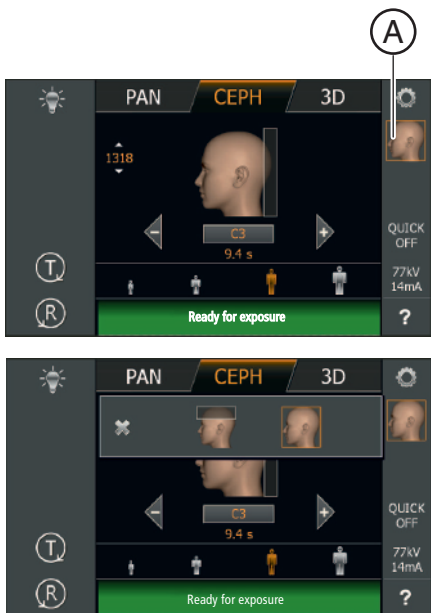

- ✓ Level 1 is displayed on the touchscreen.
- 1. Press the collimation symbol (**A**) on the right side of the touchscreen.
 - ↳ A submenu line is opened.
- 2. Select the collimation.
 - ↳ The selection is highlighted orange in the submenu line.
- 3. Touch the cross on the left side of the submenu line.
- or
- Press the collimation symbol (**A**) again.
 - ↳ The submenu line is closed.
 - ↳ The collimation is set.

5.1.2.5.5 Adjusting the Quickshot function

You can set whether the Quickshot function is to be switched on or off for each CEPH program. The Quickshot function reduces the exposure time by 30%.

✓ Level 1 is displayed on the touchscreen.

1. Touch the Quickshot display **A** on the right side of the touchscreen.
↳ A submenu line is opened.

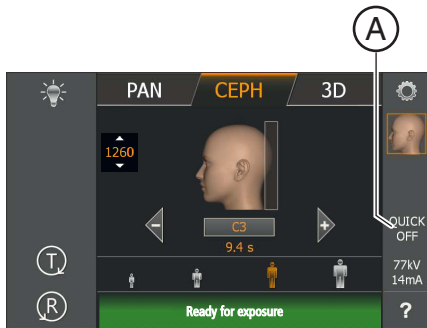

2. Press the *Quick On* or *Quick Off* icons on the touchscreen.
↳ The selection is highlighted orange in the submenu line.
3. Touch the cross on the left side of the submenu line.

or

- > Touch the Quick symbol **(A)** again.
↳ The submenu line is closed.
- ↳ The Quickshot function is set.

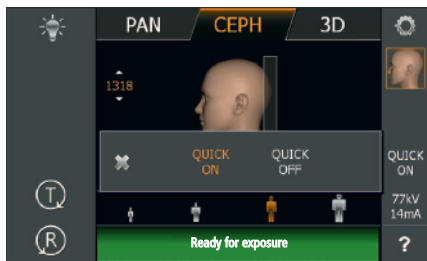

5.1.2.5.6 Setting the kV/mA values

Setting the kV/mA values via the patient symbols

Preset kV/mA combinations are assigned to the patient symbols, which are selected according to the patient's size and weight. The symbols roughly correspond to child, youth/woman, woman/man, hefty persons.

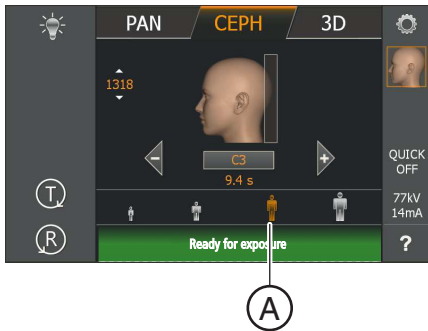

- ✓ Level 1 is displayed on the touchscreen.
- Touch the required patient symbol.
 - ↳ The selection **(A)** is highlighted in orange. The selected kV/mA value is displayed on the right side of the touchscreen.
- ↳ The kV/mA value is set.

Setting the kV/mA values via the submenu line

If the preset kV/mA combinations do not provide a satisfactory result, you can also set the kV/mA values manually in all programs.

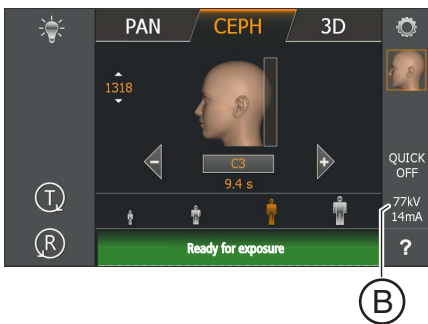

- ✓ Level 1 is displayed on the touchscreen.
- 1. Touch the kV/mA symbol **(B)** on the right side of the touchscreen.
 - ↳ A submenu line is opened.

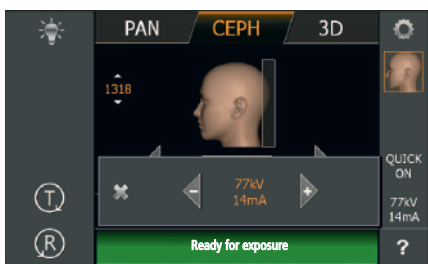

- 2. Select a kV/mA value. Touch the - or + keys.
 - ↳ The selected kV/mA value is displayed.
 - 3. Touch the cross on the left side of the submenu line.
- or
- Touch the kV/mA symbol **(B)** again.
 - ↳ The submenu line is closed.
 - ↳ The kV/mA value is set.

5.1.2.5.7 Positioning the patient

The patient is positioned on the unit while standing. Positioning in the seat is also possible without issue.

This is the case, for example, if the patient is shorter than approx. 93 cm or taller than 197 cm. In this case, you position the patient on a fixed and height-adjustable chair with a short backrest.

CAUTION

The height adjustment motor starts slowly and then increases its speed.

A patient positioned in the unit may be injured by moving parts.

- Monitor the patient and the movement of the unit during height adjustment. To make minor corrections, press and immediately release the keys. Release the button immediately in the event of involuntary contact between patient and device.

CAUTION

Hazard due to laser light.

Patients and users can be blinded by the laser light localizer.

- Prior to activating the laser light localizers, the patient **must** be asked to shut their eyes.
- Do not stare directly into the laser beam. Make sure that the laser beam does not meet the eyes of the patient.
- A distance of at least 10 cm must be maintained between the eye and the laser.

CAUTION

Reduced image quality

The image quality is limited by metal or other radiopaque materials located in the patient's mouth and in its vicinity.

- Ask the patient to take off all metallic objects such as glasses and jewelry in the head and neck area as well as all removable dental prostheses. The tray in front of the control mirror is used for depositing jewelry.

Tip: Reference values are shown for the height and forehead support settings, which are saved for further exposures in the additional information area of the SIDEXIS software.

5.1.2.5.7.1 Positioning for symmetrical exposures C1, C2

- ✓ Push the ear plug holders apart.
 - ✓ The nose support is swiveled upwards.
 - ✓ The ear plug holders are rotated at an angle of 90° towards the sensor and the secondary diaphragm.
 - ✓ The protective caps for ear plugs are inserted.
1. Set the unit height using the up (A) and down (B) keys.
CAUTION! The height adjustment motor starts slowly and then increases its speed.
Press and hold down the button until the desired height is reached. The unit movement is accompanied by a beep. Release the height-adjustment button once the Cephalometer is at the same height as that of the patient's head.
 2. Guide the patient between the ear plug holders.
 - ↳ In posterior-anterior exposure: The patient stands facing the sensor. For anterior-posterior exposure: The patient stands facing the secondary diaphragm. This position applies for both right and left-handed arms.

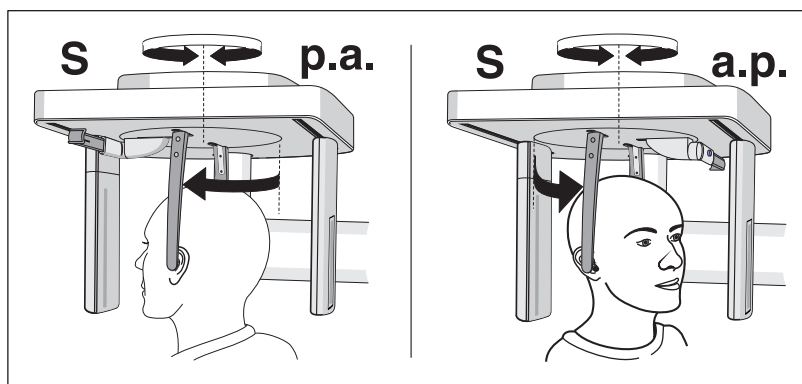
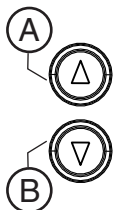

3. Grasp the ear plug holders at the top and simultaneously slide them together.
 - ↳ The ear plugs are positioned on the patient's outer auditory passage.
4. Only for program C1 p.a. and C2 a.p: Instruct the patient to tilt his head back and open his mouth as far as possible.
5. Instruct the patient to hold this position until the end of the exposure.
 - ↳ The patient is positioned in the unit.

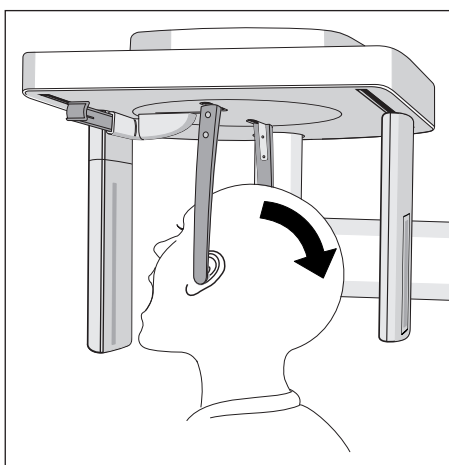

5.1.2.5.7.2 Positioning for C3 lateral exposures

- ✓ The nose support is swiveled upwards.
 - ✓ Push the ear plug holders apart.
 - ✓ The ear plug holders are in a line with the sensor and the secondary diaphragm.
 - ✓ The protective caps for ear plugs are inserted. The hygienic protective sleeve for the nose support is pulled on.
1. Set the unit height using the up (A) and down (B) keys.
CAUTION! The height adjustment motor starts slowly and then increases its speed.

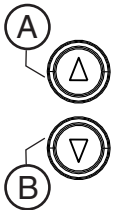

Press and hold down the button until the desired height is reached. The unit movement is accompanied by a beep. Release the height-adjustment buttons once the Cephalometer is at the same height as that of the patient's head.

2. Guide the patient backwards between the ear plug holders.
3. Grasp the ear plug holders at the top and simultaneously slide them together.
 - ↳ The ear plugs are positioned on the patient's outer auditory passage.

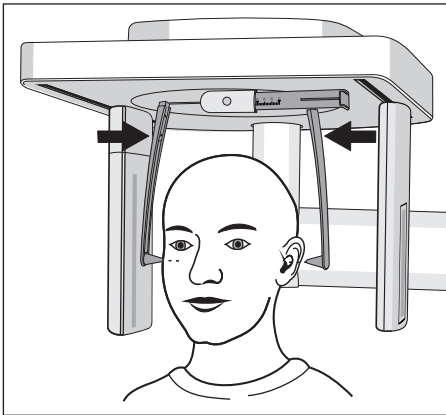

4. Switch on the light localizer. **CAUTION! Risk of dazzle**
 - ↳ A red laser line reflects on the patient's head. To switch off the light localizer, press the key again. It switches off automatically after approx. 100 seconds.

5. Align the patient's head according to the Frankfurt horizontal plane.
6. Correct the patient's head inclination as necessary. Briefly press the up (A) and down (B) height adjustment keys.

↳ The laser line reflects on the upper edge of the outer auditory passage and at the deepest point of the lower eye socket.

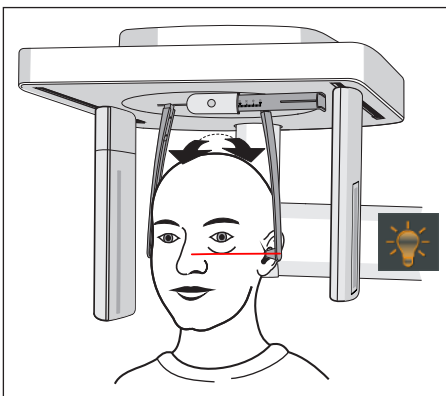

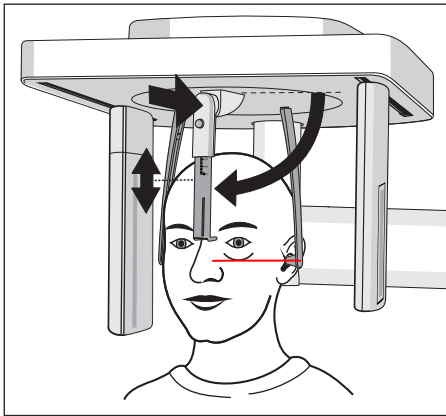

7. Optional: Swivel the nose support downward and adjust it in a vertical and horizontal direction, see "Setting/inserting the cephalometer accessories" [→ 46].
 - ↪ The nose support rests on the root of the nose.
8. Instruct the patient to hold this position until the end of the exposure.
 - ↪ The patient is positioned in the unit.

5.1.2.5.7.3 Positioning for carpal exposures C4

NOTE

The patient may press too forcefully against the carpus support plate.

This can damage the carpus support plate.

- Instruct the patient to only press lightly on the carpus support plate.

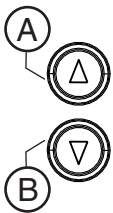

- ✓ The nose support is swiveled upwards.
 - ✓ The carpus support plate is inserted in the unit.
 - ✓ Push the ear plug holders apart.
 - ✓ The ear plug holders are rotated at an angle of 90 degrees towards the sensor and the secondary diaphragm. The nose support points towards the secondary diaphragm.
 - ✓ Hygienic protection is ensured.
1. Guide the patient sideways into the unit.
 2. Set the unit height using the up **A** and down **B** keys.
CAUTION! The height adjustment motor starts slowly and then increases its speed.
Press and hold down the button until the desired height is reached. The unit movement is accompanied by a beep. Release the height adjustment buttons once the patient can place his/her hand on the carpus support plate with the arm bent.
 3. Instruct the patient to place his hand on the carpus support plate.
 - ↳ For a cephalometer with a right-handed arm: The patient's left hand is positioned on the carpus support plate. For a cephalometer with a left-handed arm: The patient's right hand is positioned on the carpus support plate. The patient's fingertips do not protrude beyond the upper edge (**C**). The patient's hand and arm form a line.
 4. Instruct the patient to hold this position until the end of the exposure.
 - ↳ The patient is positioned in the unit.

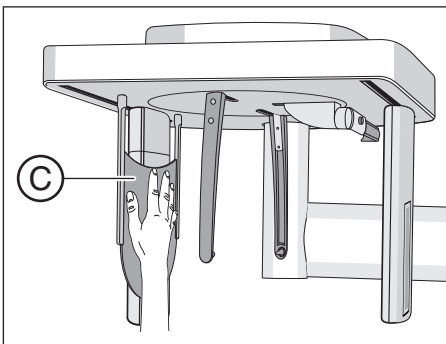

5.1.2.6 Pediatric exposures

Compared to middle-aged adults, children and adolescents are three times more at risk from radiation. A justifying indication requires that the health benefits of use outweigh the risk posed by radiation. Other procedures with similar health benefits that do not involve any, or only involve low-level, exposure to radiation must be preferred when weighing up the situation.

Medical radiation exposure as part of dental care provided to children and adolescents must produce sufficient benefits, whereby radiation exposure resulting from an X-ray examination is to be limited as much as can be accepted with the requirements of medical science (the ALARA principle).

Dentsply Sirona offers numerous options for reducing the radiation exposure for adults, and especially for children and adolescents, to a necessary minimum. Furthermore, there are numerous options for simplifying the X-ray applications for children and adolescents.

Please observe the detailed descriptions on these in the respective chapters of these Operating Instructions!

Dose reduction

Overview of the options for reducing doses, in particular for children and adolescents, with the Orthophos S:

- Using child/panorama layer imaging P10, P10A, P10C.
 - The exposures present a reduced tooth region without ascending rami. In addition, exposure times are reduced and the exposure dose is cut by up to 40% compared to panorama layer imaging P1.
- Selecting the relevant patient symbol for children/adolescents.
 - The two smallest patient symbols represent the exposure values for children/adolescents. Through their reduction in the Kv/mA values for these exposure parameters, the dose is lowered accordingly.
- Selecting the Quickshot adjustment parameter.
 - In addition to the child exposures P10, P10A, and P10C, the Quickshot function can be selected for these panorama layer images. Due to the quicker cycle, the dose is reduced by up to 40% depending on the program; the image quality is reduced a little in the process.
- Collimation to the smallest possible area / FoV for 3D exposures:
2D X-ray panorama layer imaging:
 - By showing the X-ray area on a quadrant, up to 30% of the dose can be saved with panorama layer imaging.
 - By showing the area on a quadrant in combination with the Quickshot adjustment parameter, up to 60% of the dose can be saved.
2D X-ray Ceph exposure:
 - With telerradiography, the exposure area can be shown with the programs C3 and C3 F, as well as C1 p.a and C2 a.p. This reduces the patient dose.

- In addition to this overlaying, the Quickshot adjustment parameter can also be selected in Ceph mode. This further reduces the patient dose.

3D X-rays:

- In the VOL1 volume exposure, the height of the FoV at all centers of rotation can be collimated to 5.5 cm.
- By selecting the VOL2 volume, the volume can also be reduced in diameter to 5 cm. This reduces the effective dose by approx. 30%.
- By selecting the Low Dose exposure mode, the effective dose can be reduced significantly as compared with the SD exposure mode.

Optimized X-ray applications

Overview of the options for simplifying X-ray applications for children/adolescents with the Orthophos S:

- Children and adolescents can often be positioned in a stiller and more stable position if they are seated. The Orthophos S can therefore be brought down for an exposure in the seat to a bite block height of 80 cm.
- To explain the exposure and to alleviate any fears, a radiation-free test cycle can be started at any time.
- The Orthophos S has been designed so that it functions openly and does not scare or induce fear in children and adolescents.
- There are no distressing cycle noises.
- Optimum and stable positioning options and adjustment tools prevent faulty exposures.
- The Orthophos S does not require any target exposures to check the correct patient positioning. This means no unnecessary extra dosing.

5.1.3 Releasing the exposure

5.1.3.1 Starting the test cycle

The test cycle is executed without radiation. The test cycle is used to check that the unit is functioning correctly and to ensure that a complete, uninterrupted cycle is possible. The rotating unit stops automatically if the resistance increases.

- ✓ The unit is in its starting position. Selecting an exposure program [→ 69]
- 1. Press the T key.
 - ↳ The program enters test cycle mode. On the touchscreen, the display of the kV/mA value, the exposure time and the patient symbols is hidden. Two test cycle symbols appear.
- 2. Press the release button.
 - ↳ The test cycle is started.
- 3. Wait until the test cycle has been completed.
- 4. Press the T key again.
 - ↳ The program exits test cycle mode.



5.1.3.2 Releasing the exposure

The exposure can be released using the release button on the spiral cable or the remote control. If the unit is installed in an X-ray room, which features a door edge, and the line of sight towards the patient is guaranteed, the exposure is to be released via the remote release, see "Using remote release" [→ 124].

⚠ WARNING

The unit emits X-ray radiation.

Excess exposure to X-rays is detrimental to health.

- > Use the prescribed accessories for radiation protection.
- > Do not stay in the X-ray room during exposure. Move as far away from the unit as the coiled cable for the release button allows you to.

⚠ CAUTION

The movement of the system may be adversely affected by the patient's physical constitution, clothing, or dressings, or by wheelchairs or hospital beds.

The exposure is automatically terminated if the movement of the unit is inhibited. The exposure must be repeated.

- > Ensure that the movement of the unit is not impaired when positioning the patient. Before the exposure, perform a test cycle using the T key.

 **CAUTION**

Prematurely letting go of the release button cancels the exposure immediately.

The exposure must be repeated.

- Take care not to let go of the exposure release button prematurely. Press the release button until the end of the exposure. Note that radiation may be released several times during an exposure cycle.

 **CAUTION**

The exposure memory of the unit is cleared when the unit is switched off.

Images that have not been transferred to SIDEXIS are irretrievably lost. The exposure must be repeated.

- Wait until the exposure data have been completely transferred. Do not switch the unit off before the X-ray exposure is displayed on the SIDEXIS screen.

 **CAUTION**

In the case of cephalometric exposures with right-handed arm, the secondary diaphragm and sensor automatically return to the starting position following exposure.

A patient who exits the unit too quickly risks injury from the moving parts.

- Be sure to explain the entire exposure procedure to the patient. The patient may leave only after the exposure has been taken and the secondary diaphragm and sensor have automatically returned from the cephalometer.
- ↻ Ceph arm on right side: Scanning operation from rear to front – after the exposure, the secondary diaphragm and the sensor move automatically to the rear for the positioning of the next patient.
In the left-handed arm version: Scanning operation from front to rear, secondary diaphragm and sensor remain at the rear in the position required for positioning the next patient.

 **CAUTION**

Pressing the R key moves the unit to the starting position.

A patient positioned in the unit may be injured by moving parts.

- Check that a patient is not positioned in the unit before moving it to the starting position.

IMPORTANT

Prior to exposure, ensure that you have selected the correct exposure program and accessories. Check the program display on the touchscreen and the position of the sensor.

IMPORTANT

Premature release of a new exposure is prevented by the automatic exposure blocking function. This function is used for thermal protection of the X-ray tubes.

After the release button is pressed, the message "Ready for exposure in "XX" seconds" appears in the comment line of the touchscreen.

The remaining cooling time is counted down and is displayed under "XX". Only after the cooling period has elapsed is it possible to release a new exposure.

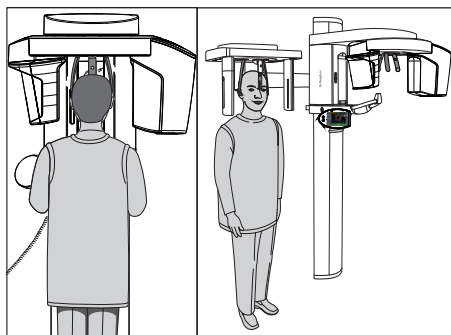

- ✓ The program settings have been made.
- ✓ The patient is positioned in the unit.
- ✓ No further auxiliary messages may be displayed in the comment line of the touchscreen. The "Ready for exposure" message must appear.

Tip: If you press the exposure release button on the remote control while the door is open, the "Close the door" message is displayed with the help code H321. Close the door and acknowledge the message.

IMPORTANT

Advise the patient of what to do during the exposure and check to make sure that they comply:

- The patient must not move his/her head in any way.
- The patient's shoulders must not be hunched.
- For cephalometric images, the arms of the patient must hang down freely at the sides.

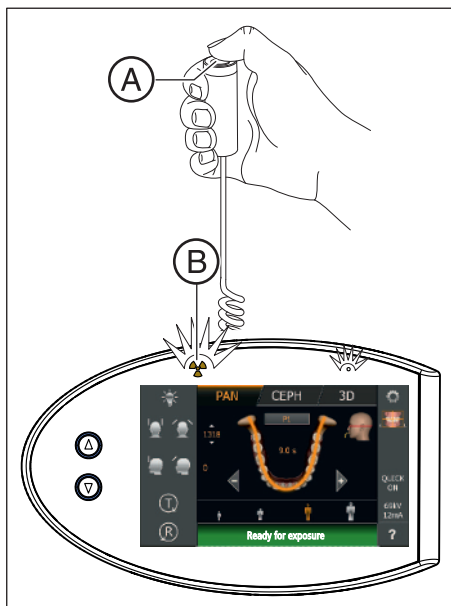

1. Press release button **(A)** and hold it down until the end of the exposure.
 - ↳ The exposure is released. "Exposure is performed" appears in the comment line on the touchscreen. During radiation, the optical radiation indicator **(B)** lights up on the Easypad. In addition, an acoustic signal sounds throughout the radiation. Radiation can be released several times during the exposure.
2. Press and hold release button **A**. Wait until a short pulsed tone sequence sounds (can be deactivated by a service engineer). The message "Please wait" appears in the comment line of the touchscreen followed by confirmation of the exposure data. Exposure mode, exposure program, tube voltage and current, actual radiation time and dose-area product are displayed.
 - ↳ The forehead and temple or temporomandibular joint supports open automatically.
3. Let go of release button **(A)**.
 - ↳ The exposure is completed.
 - ↳ The X-ray image is displayed on the PC monitor after a brief period.
4. Guide the patient out of the unit.
5. Press return key **(R)** on the Easypad.
 - ↳ Confirmation of the exposure data is acknowledged.
6. **WARNING! The patient may be injured by moving parts.** Press return key **R** on the Easypad again.



- ↳ The rotating unit moves to the starting position.
- ↳ The unit is ready for the next exposure.

Save data; see SIDEXIS



Two-part temporomandibular joint exposure program TM 1.1

In the **Two-part exposure program TM 1.1**, two exposures (TM 1.1 and TM 1.2) are made.

- ✓ Once the first temporomandibular joint exposure has been released, the message *"Please wait"* appears in the comment line on the touchscreen.
 - ✓ The rotating unit has automatically moved to the starting position.
1. Instruct the patient to open his/her mouth.
 - ↳ The patient has opened his/her mouth without changing his/her position.
 2. Press the release button **A** and hold it down until the end of the second exposure.
 - ↳ The second exposure is released. *"Exposure is performed"* appears in the comment line on the touchscreen.
 3. Wait until a short pulsed tone sequence sounds (can be deactivated by a service engineer).
 - ↳ The message *"Please wait"* appears in the comment line of the touchscreen followed by confirmation of the exposure data. Exposure mode, exposure program, tube voltage and current, actual radiation time, dose-area product are displayed.
 4. Let go of release button (**A**).
 - ↳ The second exposure is completed. Proceed as described above starting with step 5.
 - ↳ The X-ray image is displayed on the PC monitor after a brief period.

5.1.3.3 Rescue program for image transfer problems

In case of unexpected network errors or exposure interruptions, there may be problems with image transfer to Sidexis 4.

There are two options available in **Sidexis 4** for transferring images, which are described below:

- The exposure data can still be found in the exposure memory of the unit and auxiliary message H420 is displayed on the Easypad; see "Unit rescue".
- The exposure data has been transferred from the X-ray unit, but has not yet been imported into Sidexis 4, see "Data container rescue".

5.1.3.3.1 Unit rescue

CAUTION

The exposure memory of the unit is cleared when the unit is switched off.

Images that have not been transferred to SIDEXIS are irretrievably lost. The exposure must be repeated.

- Wait until the exposure data have been completely transferred. Do not switch the unit off before the X-ray exposure is displayed on the SIDEXIS screen.

- ✓ The auxiliary message H420 is displayed on the Easypad.
 - ✓ **The X-ray exposure could not be transferred, as a network fault exists or the PC failed.**
In this case, the system terminates the connection after a unit-dependent time and switches to Rescue state.
This means: That the image is not lost, but is kept in the RAM of the X-ray component by a safety mechanism until it is retrieved by SIDEXIS. A further exposure with this X-ray unit is blocked until this moment.
1. Select the X-ray unit in Rescue state.

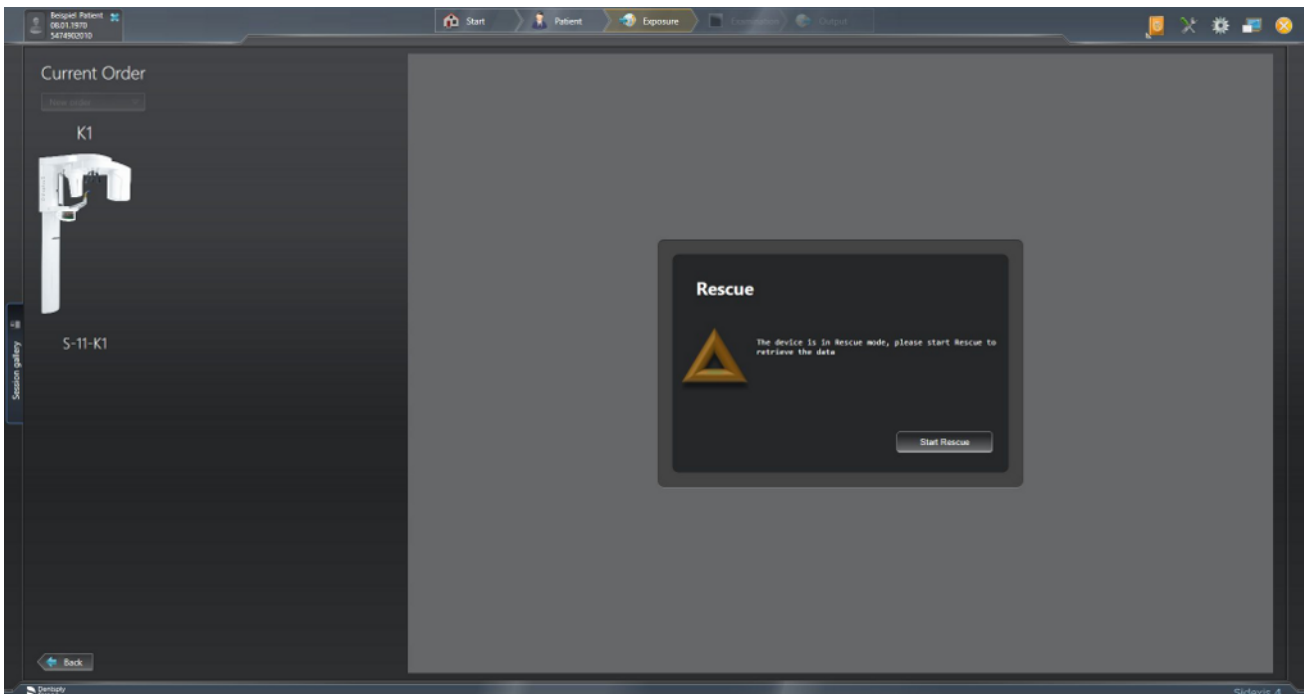

2. Click on Start rescue if the logged in patient has been X-rayed with the unit in Rescue state.
 - ↳ The program establishes a connection to the X-ray component which is in Rescue state.

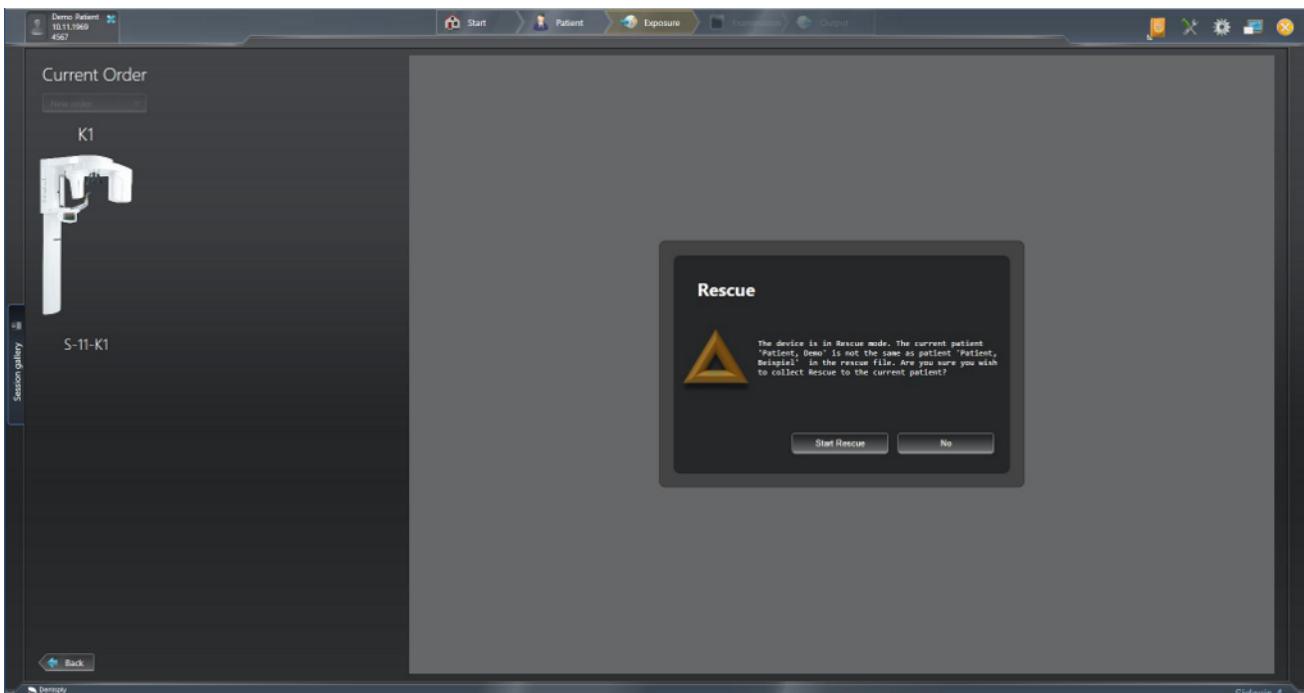

3. Click No if the patient logged in on the PC and the unit do not match.
4. Log in the patient who is in Rescue state into SIDEXIS 4 (see "Sidexis 4 Operator's Manual") and click on the "Start rescue" button.

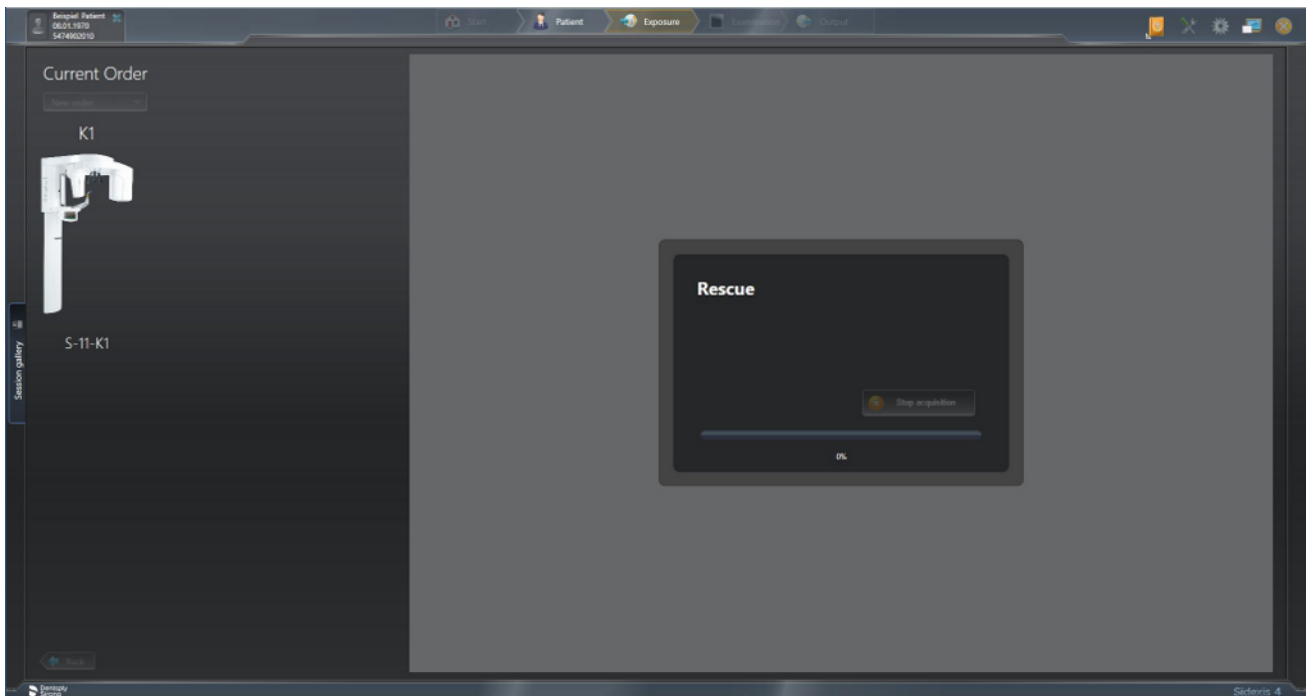

↪ If a connection is successfully established, data is transferred.

IMPORTANT

The displayed exposure may in certain circumstances indicate a lower level of quality if the exposure procedure was terminated prematurely or a data transfer problem occurred between the unit and the reconstruction server.

5.1.3.3.2 Data container rescue

✓ Data are available which have not yet been transferred to the Sidexis 4 database.

1. Start Sidexis 4.

↳ The data container rescue view is displayed if when enabling exposure readiness, patient exposures are available that have not yet been imported into the Sidexis 4 database. In this case, a Unit rescue H420 (5.1.3.3.1) is not available. The table contains an entry for each patient exposure which has not yet been imported into the Sidexis 4 database.

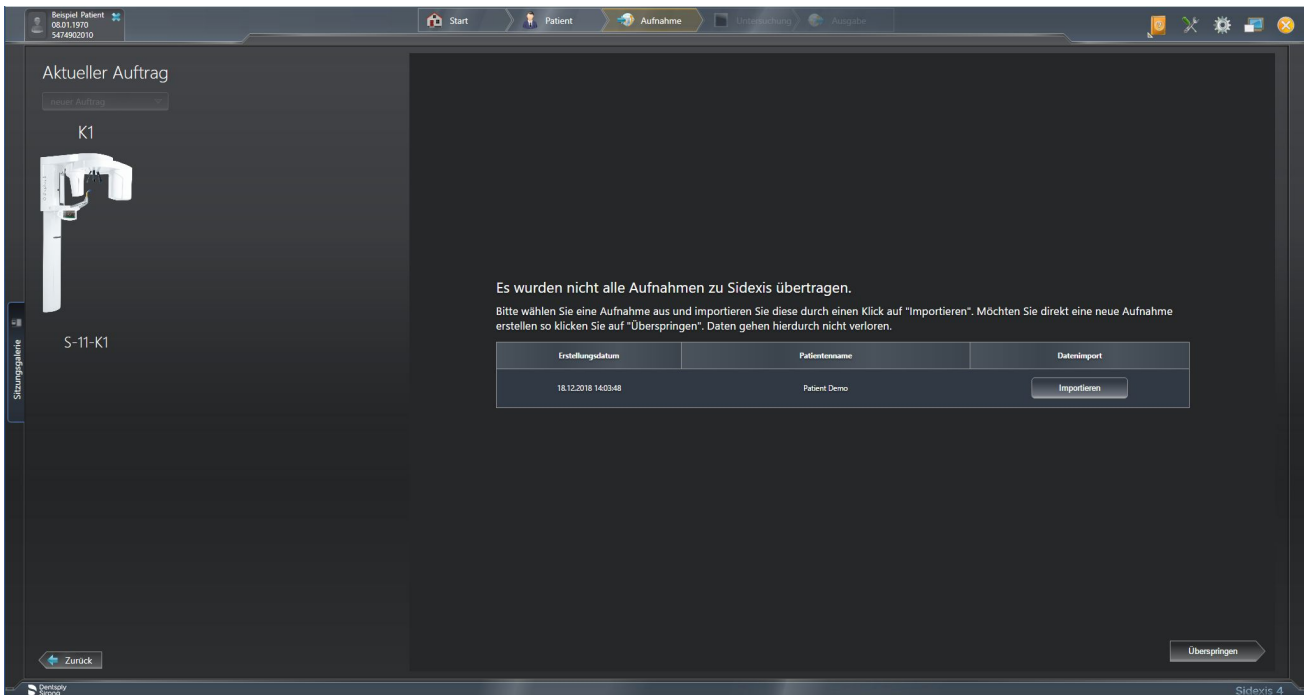

2. Select an exposure and import it by clicking on 'Import'.

↳ The exposure is displayed in the "Light box" of Sidexis 4.

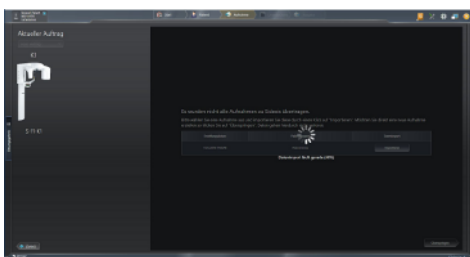

5.1.3.4 Using the remote control

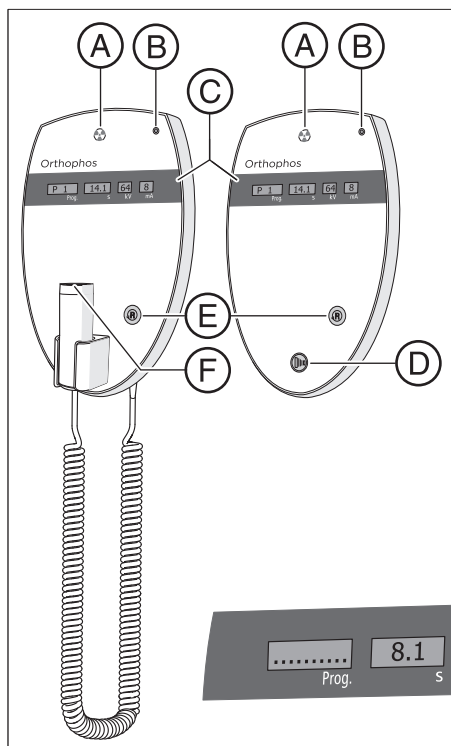

On the remote control, exposures are triggered using the release button **(D)**. If it is not possible to maintain visual contact with the patient when releasing the exposure, the release key with the coiled cable **(F)** on the X-ray unit can be removed and used on the remote control.

If the unit is ready for exposure and no auxiliary messages are displayed, the current program parameters appear on display **(C)**: Program designation, exposure time, voltage, current in the individual fields (*Prog.*, *s*, *kV*, *mA*). The exposure can be released now.

If plain-text help messages are displayed on the Easypad touchscreen, they also appear in coded form on the *Prog.* display of the remote control, alternating with the program name.

When switching on the unit, the X-ray indicator **A** lights up for a functional check for approx. 1 second.
The LED **B** lights up when the unit is on.

Use the Return key **E** to acknowledge exposures, error messages and auxiliary messages and move the rotating unit to the starting position.

If a row of dots appears in the *Prog.* field on the digital display **(C)**, this means the unit is currently in a preparatory phase (e.g. unit movements, parameter settings, program loading times, etc.). Wait until the dots disappear automatically and the system is ready for operation.

5.1.3.5 Canceling an exposure

An exposure that has been triggered can be canceled again at any time.

CAUTION

Pressing the R key moves the unit to the starting position.

A patient positioned in the unit may be injured by moving parts.

- > Check that a patient is not positioned in the unit before moving it to the starting position.

- ✓ The exposure is released.
- 1. Let go of the exposure release button.
 - ↳ The exposure is immediately terminated.
Message H320 appears.
The exposure data of the terminated exposure is displayed in SIDEXIS.
The radiation time and dose-area product flash.
- 2. Guide the patient out of the unit.
- 3. Press the R key.
 - ↳ The actual required radiation time is acknowledged.
- 4. Press the R key again.
 - ↳ The rotating unit moves to the starting position.
- ↳ The unit is now ready for the next exposure.

IMPORTANT

The program settings must be checked before the exposure is repeated. Any changed program settings must be preselected again.



5.2 Preselecting basic settings

5.2.1 Changing the basic settings and start settings

5.2.1.1 PAN program group

In level 2:

In the basic settings, the stored kV/mA values for the patient symbols can be adjusted for each program.

In the default settings, the pre-selection of the patient symbol can be changed and the enabling/disabling the Quickshot function can be preset.

Basic settings: changing the kV/mA values of the patient symbols

✓ Level 1 of the PAN program group is displayed on the touchscreen.

1. Touch the toothed wheel **A** in the upper right corner of the touchscreen.
 - ↳ Level 2 is displayed.

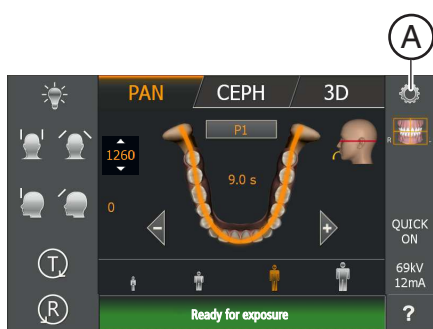

2. Select the exposure program for which you want to change the kV/mA value. Touch the - or + arrows.
 - ↳ The selected setting is displayed on the right side of the touchscreen.
3. Select the patient symbol for which you want to change the kV/mA value.
4. Select the kV/mA value that you want to apply to the selected program and patient symbol.
5. Touch the save symbol **(B)**.
 - ↳ The kV/mA value is saved for the selected program and patient symbol.
6. Repeat this procedure for the other patient symbols and programs.
 - ↳ The settings for the kV/mA values stored for the patient symbols have been made.

Start settings: Changing the start settings for the patient symbol and selecting enabling/disabling the Quickshot function

✓ Level 2 of the PAN program group is displayed on the touchscreen.

1. Touch the diskette symbol **(C)** at the top of the touchscreen.
 - ↳ The start settings are displayed.

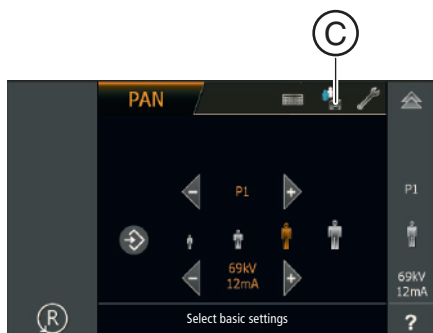

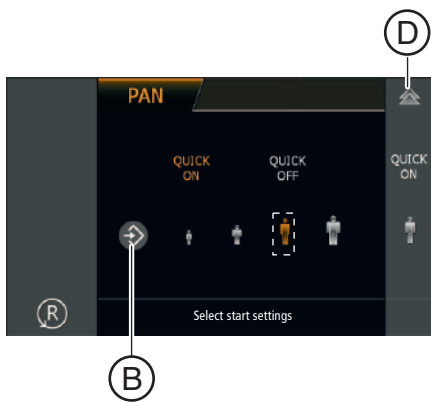

2. Select the patient symbol that you want to preset.
 - ↳ The selection is highlighted in orange and displayed on the right side of the touchscreen.
3. Select whether the Quickshot function should be switched on or off. Press the *Quick On* or *Quick Off* icons on the touchscreen. The Quickshot function reduces the cycle time by approx. 20 to 50%, depending on the exposure program. The function is set independently of the exposure program.
 - ↳ The selection is highlighted in orange and displayed on the right side of the touchscreen.
4. Touch the save symbol **(B)**.
 - ↳ The setting is saved for the PAN program group.
5. Touch the double triangle **D** in the upper right corner of the touchscreen.
 - ↳ The start settings are hidden, level 1 is displayed.

5.2.1.2 3D program group

The preselection of the 3D exposure mode and the patient symbol can be changed with the start settings.

Changing start settings for 3D exposure mode and patient symbol

✓ Level 1 of the 3D program group is displayed on the touchscreen.

1. Touch the toothed wheel **A** in the upper right corner of the touchscreen.
 - ↳ Level 2 is displayed.



2. Touch the diskette symbol **B** at the top of the touchscreen.
 - ↳ The start settings are displayed.
3. Select whether HD or SD exposure mode is preset.
 - ↳ The selection is highlighted in orange.
4. Touch the save symbol **C**.
 - ↳ The setting is saved for the 3D program group.

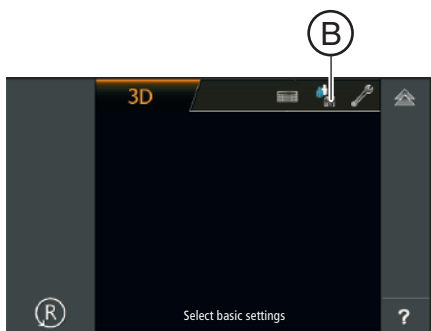

5. Select the patient symbol that you want to preset.
 - ↳ The selection is highlighted in orange.
6. Touch the save symbol **C**.
 - ↳ The setting is saved for the 3D program group.
7. Touch the double triangle **D** in the upper right corner of the touchscreen.
 - ↳ The start settings are hidden, level 1 is displayed.

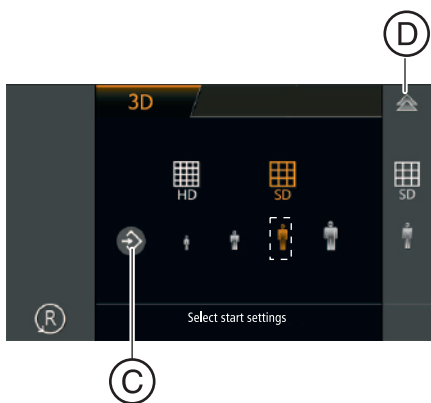

5.2.1.3 CEPH program group

In level 2:

In the basic settings, the stored kV/mA values for the patient symbols can be adjusted for each program.

In the default settings, the pre-selection of the patient symbol can be changed and the enabling/disabling the Quickshot function can be preset.

Basic settings: changing the kV/mA values of the patient symbols

✓ Level 1 of the CEPH program group is displayed on the touchscreen.

1. Touch the toothed wheel **A** in the upper right corner of the touchscreen.
↳ Level 2 is displayed.

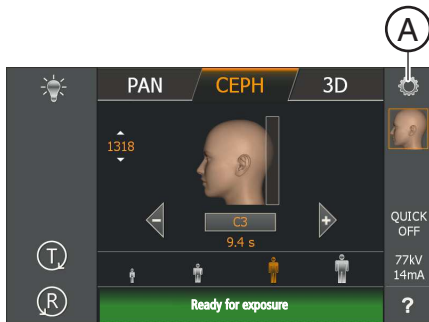

2. Select the exposure program for which you want to change the kV/mA value. Touch the - or + arrows.
↳ The selected setting is displayed on the right side of the touchscreen.
3. Select the patient symbol for which you want to change the kV/mA value.
4. Select the kV/mA value that you want to apply to the selected program and patient symbol.
5. Touch the save symbol **(B)**.
↳ The kV/mA value is saved for the selected program and patient symbol.
6. Repeat this procedure for the other patient symbols and programs.
↳ The settings for the kV/mA values stored for the patient symbols have been made.

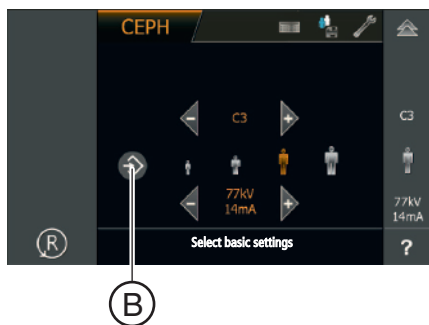

Start settings: Changing the start settings for the patient symbol and selecting enabling/disabling the Quickshot function

✓ Level 2 of the CEP program group is displayed on the touchscreen.

1. Touch the diskette symbol **(C)** at the top of the touchscreen.
↳ The start settings are displayed.

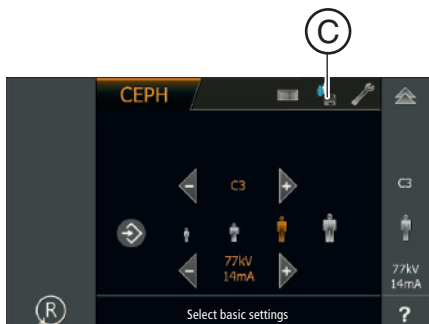

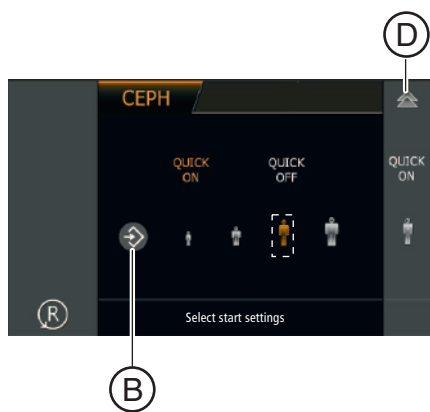

2. Select the patient symbol that you want to preset.
 - ↳ The selection is highlighted in orange and displayed on the right side of the touchscreen.
3. Select whether the Quickshot function should be switched on or off. Press the *Quick On* or *Quick Off* icons on the touchscreen. The Quickshot function reduces the cycle time by approx. 20 to 50%, depending on the exposure program. The function is set independently of the exposure program.
 - ↳ The selection is highlighted in orange and displayed on the right side of the touchscreen.
4. Touch the save symbol **(B)**.
 - ↳ The setting is saved for the CEPH program group.
5. Touch the double triangle **D** in the upper right corner of the touchscreen.
 - ↳ The start settings are hidden, level 1 is displayed.

5.2.2 Adjusting the touchscreen

A touch-sensitive click tone is issued as an acoustic confirmation following every input on the touchscreen. The click tone can be switched on and off.

The intensity of the touchscreen display can also be adjusted depending on the current lighting conditions.

IMPORTANT

Once the PAN screen is displayed the intensity of the touchscreen display can be adjusted. This is approximately 70 seconds after the unit is switched on.

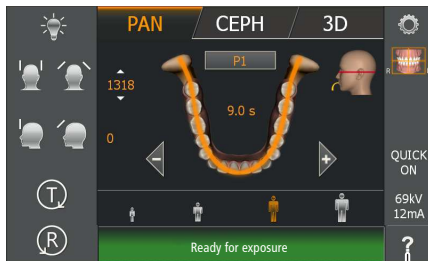

A

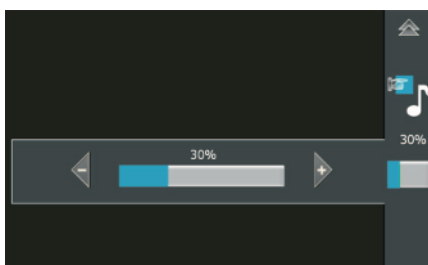
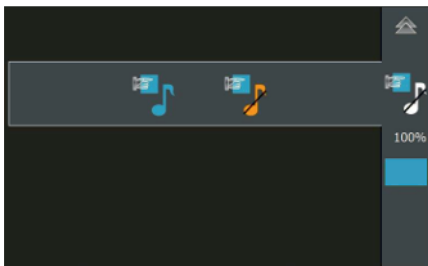

- ✓ Level 1 is displayed on the touchscreen.
- 1. Touch the question mark **(A)** in the lower right corner of the touchscreen.
 - ↳ The display for setting the click tone and the intensity of the touchscreen display appears.
- 2. Touch the musical note icon.
 - ↳ The subline menu for the click tone is opened.
- 3. Switch the click tone on or off.
 - ↳ The selection is highlighted in orange.
- 4. Touch the selected symbol in the right-hand column again.
 - ↳ The subline menu for the click tone closes.
- 5. Touch the green-white field in the bottom right corner of the touchscreen.
 - ↳ The subline menu for the intensity of the touchscreen display is opened.
- 6. Set the intensity by touching the -/+ keys.
 - ↳ The intensity of the touchscreen display and the reference value over the green-white field change.
- 7. Touch the selected symbol in the right-hand column again.
 - ↳ The subline menu for the intensity of the touchscreen display closes.
- 8. Touch the double triangle in the upper right corner of the touchscreen.
 - ↳ Level 1 is displayed.
- ↳ The click tone and the intensity of the touchscreen display are set.

5.2.3 Calling the info screen

The Info screen lists unit data that is useful for any discussions with your service engineer.

✓ The touchscreen display is located on level 1.

1. Touch the toothed wheel (A) in the upper right corner of the touchscreen.

↳ The touchscreen display is located on level 2.

2. Touch the question mark (B) in the lower right corner of the touchscreen.

↳ The info screen is displayed.

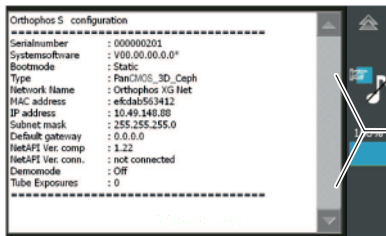
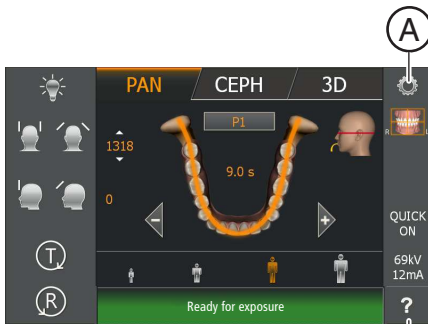

3. Touch the arrows (C) in the scroll bar to the right of the list.

↳ The next or previous page of the list is displayed.

4. Touch the double triangle in the upper right corner of the touchscreen.

↳ The display changes to level 1.

5.2.4 Calling the service menu

The service menu is intended exclusively for service engineers. Service routines can be activated and unit settings incl. tests and calibrations can be performed in this menu.

✓ The touchscreen display is located on level 1.

1. Touch the toothed wheel **A** in the upper right corner of the touchscreen.
↳ Level 2 is displayed.

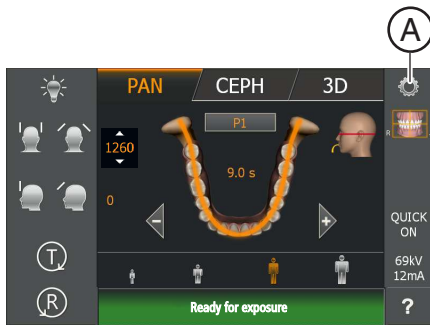

2. Touch the wrench symbol **(B)**.
↳ The display for entering the service password appears.

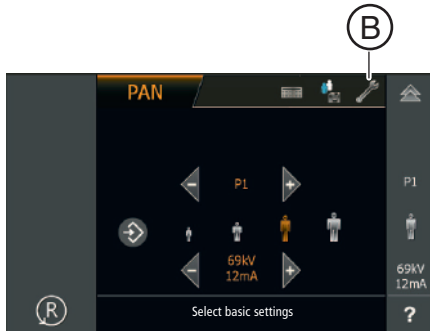

3. Enter the service password as described in the Installation Instructions or in the Service Manual.
↳ The service menu is displayed after it has been accessed.

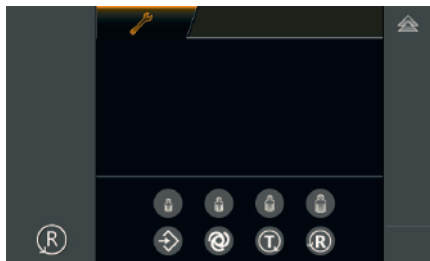

- ↳ The service menu is called.

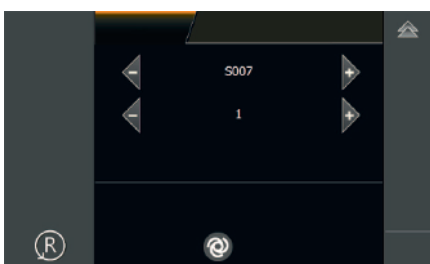

6 Service

6.1 Cleaning and care

6.1.1 Cleaning

Remove dirt, grime and disinfectant residue regularly using mild, commercially available cleaning agents.

NOTE

When cleaning or disinfecting, liquids may enter the unit or the release button via the ventilation slots.

Electrical components of the system can be destroyed by liquids.

- > Do not spray any liquids into the ventilation slots or the release button.
- > First spray the liquid onto a cleaning cloth. Then wipe the ventilation slots or release button with the cleaning cloth.
- > Make sure that no liquids run along the surface into the ventilation slots or release button.

6.1.2 Disinfecting

Only the external surfaces may be disinfected with approved chemical disinfectants. Use only disinfectants that comply with the valid requirements of the respective national regulatory body or whose bactericidal, fungicidal, and virucidal properties have been verifiably tested and approved accordingly.

NOTE

Cleaning and care agents may contain aggressive ingredients.

Unsuitable cleaning and care agents are detrimental to health and attack the surface of the unit.

- > Do NOT use: Substances containing phenol, peracetic acid, peroxide, or any other oxygen-splitting agents, sodium hypochlorite, or iodine-splitting agents.
- > Use only cleaning and disinfecting agents approved by Dentsply Sirona.

A continuously updated list of approved agents can be downloaded from the Internet on the online portal for technical documents. The portal can also be accessed directly via the following address:
www.dentsplysirona.com/manuals

Click on the menu item "*General documents*" and then open the "*Care, cleaning and disinfection agents*" document.

If you do not have access to the Internet, you can order the list in one of the following two ways:

- Order from your local dental depot
- Order from Dentsply Sirona
Phone: ++49 (0) 62 51/16-16 70
Fax: ++ 49 (0) 62 51/16-18 18

REF 59 70 905

6.1.3 Sterilization

WARNING

Infections can be transmitted from patient to patient.

Accessories that are not sterilized correctly can cause illness in patients.

- > All accessories that are suitable for sterilization should only be sterilized in an autoclave at 132 °C (270 °F), with at least 4 minutes holding time and at 2.1 bar (30.5 psi) overpressure.

The following accessories can be sterilized:

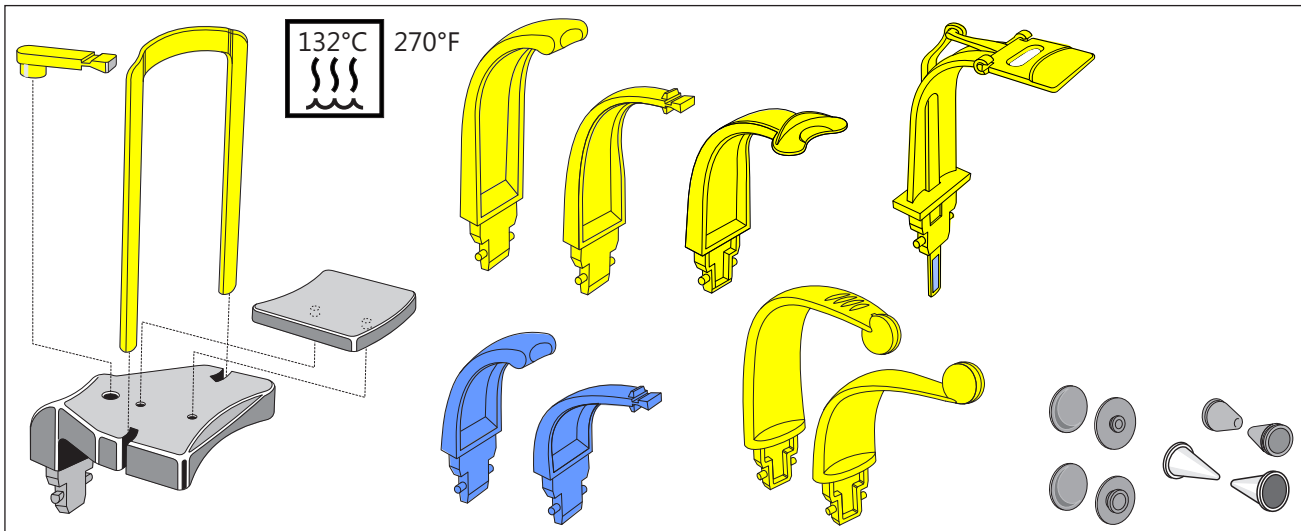

In addition, also use the hygienic protective sleeves; see 'Hygienic protective sleeves' [→ 39].



WARNING

The hygienic protective sleeves are single use devices.

Contaminated hygienic protective sleeves can cause illness in patients.

- > Replace the hygienic protective sleeves after each patient.

6.1.4 Cleaning the occlusal bite block

If the hinges of the occlusal bite block begin to squeak during operation after prolonged periods of use, they must be cleaned.

1. Unplug the occlusal bite block from its holder on the unit.
2. Gently push apart the guide mandrel of the lever (A) on the bite block plate and the eyelet of the rod (B) in the direction of the arrows and unhinge the lever.

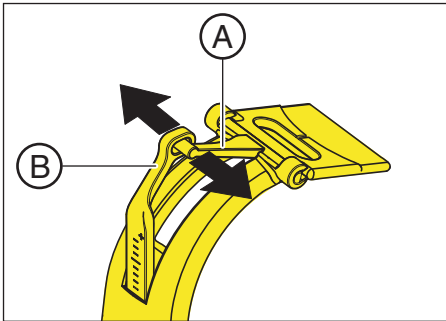

3. Swivel the bite block plate (C) vertically upward so that the lever (A) is pointing downwards.

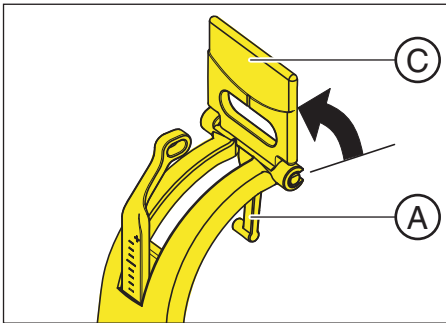

4. Pull the bite block plate (C) forwards out of its hinge.

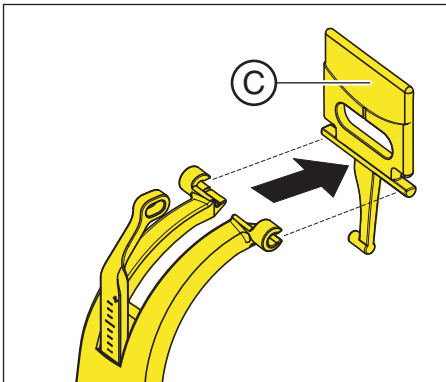

5. Clean the hinge axles (D) and the guide lugs (E) with disinfectant.
6. Assemble the occlusal bite block by following the same procedure in reverse order. When assembling, check the position of the bite block plate; the segment must point toward the connecting lever.
7. Plug the occlusal bite block back into its holder on the unit.

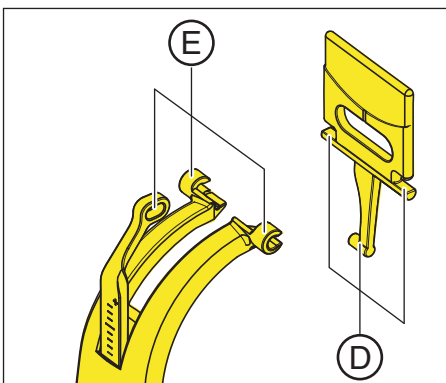

6.2 Inspection and maintenance

Inspection and preventive maintenance must be performed at scheduled intervals to protect the health and safety of patients, users, and other persons.

The information provided in the document "*Inspection and maintenance and safety-related checks*" REF 64 95 100 should be helpful here. The document can be downloaded at <http://www.dentsplysirona.com/manuals>.

Annual inspection

In order to ensure the operational safety and functional reliability of your product, you as the system owner should check the equipment at regular intervals (at least once a year) or commission your dental depot to do so.

In the event of visible external damage, commission your dental depot with an inspection of the unit.

Maintenance by the service engineer

In addition to the annual check to be carried out by the system owner or authorized persons, preventive maintenance must be performed after 4, 7 and 10 years, and then at two-year intervals.

Checking image quality

The image quality should be assessed by the system owner at regular intervals, at least once a year.

On digital image receptor systems, the degree of postprocessing (brightness or contrast adjustment) that is required in the image processing software (e.g. SIDEXIS) to produce satisfactory results is used as an assessment criterion.

Worldwide: Quality inspection

If a unit defect cannot be ruled out in the event of an image that cannot be evaluated, it is imperative a quality inspection is performed by an authorized service technician.

Germany: Constancy test

Unit:

Please note the legally required regular checks of the image quality of your X-ray device as stipulated in your country (e.g., RöV, the German X-ray Ordinance). Dentsply Sirona provides you with the Sidexis software for easy implementation of this constancy test and for its documentation.

The required test specimen and the description of the constancy test come with the unit.

In the event of a constancy test that cannot be evaluated, the unit must be taken out of service. In this case, contact an authorized dealer.

Diagnostic monitor:

In Germany, a regular constancy test of the results monitor is required by the X-ray Ordinance in accordance with DIN 6868-157. To easily implement the necessary legal requirements, Dentsply Sirona provides the Simocon software. You can find this software and the operating instructions that belong to it on your Sidexis CD under the "Tools" section.

Country-specific requirements

Observe any possible additional country-specific requirements.

7 Malfunctions

7.1 Help messages

When working with the unit, auxiliary messages are displayed for certain actions (e.g. press H301 for the return key), which call for the user to perform a specific action. These auxiliary messages are listed below. If an error occurs, error messages are output starting with "E" followed by 5 digits, see "Error description" [→ 143].

- ✓ The unit is switched on and ready for operation.
- 1. Press the release button.
 - ↳ The message H3/H4 xx appears.
- 2. See list below about how to proceed to make the system ready for exposure.

H301 – R button, move into starting position

The rotating unit is not in the starting position.

CAUTION

Pressing the R key moves the unit to the starting position.

A patient positioned in the unit may be injured by moving parts.

- > Check that a patient is not positioned in the unit before moving it to the starting position.

- > Press the R key.
 - ↳ The unit travels to the starting position.

H307– Change bite block

The occlusal bite block cannot be used for the selected exposure program.

- > Remove the occlusal bite block from the unit, use the positioning aid that matches the exposure type.
 - ↳ The program sequence is continued.

H320 – R button, confirm exposure data

The exposure data have not been acknowledged yet.

- > Press the R key.
 - ↳ Exposure data are confirmed.

H321 – Close the door

Check door contact of the X-ray room.

- > Close the door to the X-ray room.
 - ↳ The contact switch on the door is closed.

H322 – Select quadrant

No quadrant is selected.

- > Select the desired quadrant.
 - ↳ The program sequence is continued.

H325 – Select region of exposure

No volume area selected.

- > A dental arch showing the volume areas is displayed on the touchscreen. Touch an area to select it.
 - ↳ The program sequence is continued.

H403 – Switch SIDEXIS to ready for exposure state

SIDEXIS is not ready for exposure.

- > Switch SIDEXIS to a ready-for-exposure state; see the SIDEXIS user manual.

H406 – R button, move into Ceph starting position

Ceph is not in the starting position.

- > Press the R key.
 - ↳ The unit travels to the starting position.

H420 – Rescue: do not switch off; see Rescue program for image transfer problems

The image could not be transferred to SIDEXIS.

CAUTION

The exposure memory of the unit is cleared when the unit is switched off.

Images that have not been transferred to SIDEXIS cannot be restored using Unit Rescue.

- > Never switch off the unit before transferring the images to SIDEXIS.

- > Save the exposure using Unit Rescue.
 - ↳ The image is transferred to SIDEXIS.

7.2 Error message structure

The error messages are displayed on the device in the form of an error code. The display does not show any plain text error output.

The error codes are structured according to the following pattern: **Ex yy zz**

Explanation of abbreviations:

Ex – Error type

The x character provides a foundation for making quick decisions as to how serious the error is and how to handle the error.

yy – Locality

Describes the impaired function of the device.

zz – Identification

Further specification of the error with a consecutive number.

7.3 Error description

7.3.1 Ex – Error type

NOTE

The unit must not be switched on/off constantly.

Constant switching on and off reduces the service life of individual unit components and results in increased power consumption.

- After switching the unit off, wait for approx. 60 seconds before switching it on again.

E1 – System warning/message

The error is in an acceptable tolerance range. Device operation is not directly impaired.

1. Acknowledge the error message.
2. Contact your Customer Service.
 - ↳ Continued device operation is ensured.

E2 – Overload

The error can be traced back to temporary overheating or something similar.

1. Acknowledge the error message.
2. Wait for a moment and repeat the procedure step. If the error reappears, extend the waiting time.
 - ↳ The error no longer occurs after a certain waiting period.
3. If the error persists, contact your Customer Service.

E3 – Key pressed during power-up

The error results from an invalid signal state due to pushing buttons and security signals during power-up.

1. Switch the unit off and on again. **NOTE! Observe waiting period!**
2. If the error persists, contact your Customer Service.

E4 – mechanical blocking

Errors that indicate mechanical blocking of motor-driven parts.

1. Check whether the device is mechanically blocked.
 - Remove items.
2. Switch on/off. Check whether the error reoccurs.
 - If the error remains permanently, inform customer services.

E5 – Malfunction during exposure or exposure preparation

Error resulting from a certain system action triggered by the user which could not be performed because a required (internal) partial function (software or hardware) is not ready or fails.

1. Acknowledge the error message.
2. Repeat the last procedure step or exposure.
 - ↳ The error no longer occurs.
3. If the error persists, contact your Customer Service.

E6 – Self-check

The error occurs spontaneously and without a corresponding operation.

1. Acknowledge the error message.
 - ↳ The error no longer occurs.
2. If the error remains, switch the unit off and on again. **NOTE!**
Observe waiting period!
 - ↳ The error no longer occurs.
3. If the error persists, contact your Customer Service.

E7 – Serious system error

The error occurs spontaneously and without a corresponding operation.

1. Switch off the unit.
2. Contact your Customer Service immediately.
 - ↳ The unit is functional.

7.3.2 yy – Locality

The location may be a DX module number standing for an entire HW function unit, or a logical SW function unit on board DX11 (central control).

06 – Tube assembly

07 – Easypad user interface

10 – Central control DX 11; system hardware

11 – Central control DX 11; system software

12 – Central control DX 11; central CAN bus fault

13 – Central control DX 11; DX11, DX1 periphery (motor system of stand, sensor system of stand)

14 – Central control DX 11; digital extension (HSI, network, etc.)

15 – Central control DX 11; configuration (wrong software, wrong module constellation, etc.)

16 – Central control DX 11; Zero Management

20 – Central control DX 11; Framegrabber application

22 – Central control DX 11; 2D Imaging System

23 – Central control DX 11; 3D Imaging System

42 – Remote

61 – Diaphragm control

81 – Ceph Sensor

83/831 – DX83 Sensor

91 – Ceph digital

8 Settings and repair

8.1 Program values

8.1.1 Panoramic exposure index 1E

Code 1E

This level series is factory programmed for the Federal Republic of Germany. The code 1E, which specifies a reduced level series for children and young people, should at least be complied with by law for new installations or relocation/ shifting of operations since 01/01/1999 in the Federal Republic of Germany. Furthermore, this level series can also be applied worldwide.

Level series for code 1E

Program	Pro-gram dura-tion approx.	Max. expo-sure time	Quick-shot program duration approx.	Max. Quick-shot exposure time	Factory setting				User-defined values – Please enter here –			
P1	19.0s 12.9s	14.1s 8.0s	14.2s 10.3s	9.0s 5.1s	63/6	63/8	69/12	72/14				
P1A	21.8s 15.4s	14.1s 8.0s	18.2s 13.9s	9.0s 5.1s	63/6	63/8	69/12	72/14				
P1C	20.1s 13.3s	14.1s 8.0s	17.1s 12.6s	10.5s 5.9s	63/6	63/8	69/12	72/14				
P2	16.4s 11.6s	11.5s 6.7s	12.4s 9.4s	7.3s 4.2s	63/6	63/8	69/12	72/14				
P2A	18.0s 12.1s	11.5s 6.7s	15.0s 11.8s	7.3s 4.2s	63/6	63/8	69/12	72/14				
P2C	16.8s 11.7s	11.5s 6.7s	13.7s 9.7s	8.5s 4.9s	63/6	63/8	69/12	72/14				
P10	16.4s 11.6s	11.5s 6.7s	11.4 s 9.4 s	7.3s 4.2s	63/6	63/8	69/12	72/14				
P10A	18.0s 12.1s	11.5s 6.7s	15.0s 11.8s	7.3s 4.2s	63/6	63/8	69/12	72/14				
P10C	16.8s 11.7s	11.5s 6.7s	13.7s 9.8s	8.5s 4.9s	63/6	63/8	69/12	72/14				
P12	11.9 s	4.9s			69/8	75/8	78/14	84/12				
BW1	23.0s 23.0s	8.8s 4.5s			63/6	63/8	69/12	72/14				
BW2	18.0 s	5.1 s			63/6	66/8	69/12	72/14				
TM1.1+ TM1.2	16.1+ 16.1s	6.4+ 6.4s			66/8	69/8	72/14	75/14				
TM3	18.4 s	8.1 s			63/8	66/8	69/12	72/14				

Program	Pro-gram dura-tion ap-prox.	Max. expo-sure time	Quick-shot program duration approx.	Max. Quick-shot ex-posure time	Factory setting				User-defined values – Please enter here –			
S1	19.8s	14.4 s			69/8	75/8	78/14	84/12				
S3	20.0 s	8.1 s			69/8	75/8	78/14	84/12				

Possible kV/mA combinations for preselected patient symbols 1 and 2 for code 1E selectable using the +/- buttons on the kV/mA setting

kV	60	60	60	60	60	63	63	66	69	72	75	78	81	84	90
mA	3	5	6	7	8	6	8	8	8	8	8	7	7	6	6

Possible kV/mA combinations for preselected patient symbols 3 and 4 for code 1E selectable using the +/- buttons on the kV/mA setting



















kV	60	60	60	60	60	63	63	69	69	72	75	78	81	84	90
mA	8	10	12	14	16	14	16	12	16	14	14	14	12	12	12

8.1.2 Panoramic exposure index 2E

Code 2E

It guarantees that the applicable legal regulations which must be complied with since January 1, 1999 are strictly observed. Furthermore, this level series can also be applied worldwide. National regulations must be complied with. The table lists the maximum exposure times.

Level series for code 2E

Program	Program duration approx.	Max. exposure time	Quick-shot program duration approx.	Max. Quick-shot exposure time	Factory setting				User-defined values – Please enter here –			
												
P1	 19.0s 12.9s	14.1s 8.0s	14.2s 10.3s	9.0s 5.1s	63/6	63/8	69/8	72/8				
P1A	 21.8s 15.4s	14.1s 8.0s	18.2s 13.9s	9.0s 5.1s	63/6	63/8	69/8	72/8				
P1C	 20.1s 13.3s	14.1s 8.0s	17.1s 12.6s	10.5s 5.9s	63/6	63/8	69/8	72/8				
P2	 16.4s 11.6s	11.5s 6.7s	12.4s 9.4s	7.3s 4.2s	63/6	63/8	69/8	72/8				
P2A	 18.0s 12.1s	11.5s 6.7s	15.0s 11.8s	7.3s 4.2s	63/6	63/8	69/8	72/8				
P2C	 16.8s 11.7s	11.5s 6.7s	13.7s 9.7s	8.5s 4.9s	63/6	63/8	69/8	72/8				
P10	 16.4s 11.6s	11.5s 6.7s	11.4s 9.4s	7.3s 4.2s	63/6	63/8	69/8	72/8				
P10A	 18.0s 12.1s	11.5s 6.7s	15.0s 11.8s	7.3s 4.2s	63/6	63/8	69/8	72/8				
P10 C	 16.8s 11.7s	11.5s 6.7s	13.7s 9.8s	8.5s 4.9s	63/6	63/8	69/8	72/8				
P12	 11.9 s	4.9 s			69/8	75/8	78/7	84/6				
BW1	 23.0s 23.0s	8.8s 4.5s			63/6	63/8	69/8	72/8				
BW2	18.0 s	5.1 s			63/6	66/8	69/8	72/8				
TM1.1+ TM1.2	16,1+ 16.1s	6,4+ 6.4s			66/8	69/8	72/8	75/8				
TM3	18.4 s	8.1 s			63/8	66/8	69/8	72/8				
S1	19.8 s	14.4 s			69/8	75/8	78/7	84/6				
S3	20.0 s	8.1 s			69/8	75/8	78/7	84/6				

**Possible kV/mA combinations for code 2E selectable using the +/-
buttons on the kV/mA setting**

kV	60	60	60	60	60	63	63	66	69	72	75	78	81	84	90
mA	3	5	6	7	8	6	8	8	8	8	8	7	7	6	6

8.1.3 Panoramic exposure index 3E

Index 3E

It guarantees that the applicable legal regulations which must be complied with since January 1, 1999 are strictly observed. Furthermore, this level series can also be applied worldwide. National regulations must be complied with. The exposure times indicated represent the corresponding maximum.

Level series for index 3E

Program	Program duration approx.	Max. exposure time	Quick-shot program duration approx.	Max. Quick-shot exposure time	Factory setting				User-defined values – Please enter here –			
P1	19.0s 12.9s	14.1s 8.0s	14.2s 10.3s	9.0s 5.1s	63/6	63/8	69/12	72/14				
P1A	21.8s 15.4s	14.1s 8.0s	18.2s 13.9s	9.0s 5.1s	63/6	63/8	69/12	72/14				
P1C	20.1s 13.3s	14.1s 8.0s	17.1s 12.6s	10.5s 5.9s	63/6	63/8	69/12	72/14				
P2	16.4s 11.6s	11.5s 6.7s	12.4s 9.4s	7.3s 4.2s	63/6	63/8	69/12	72/14				
P2A	18.0s 12.1s	11.5s 6.7s	15.0s 11.8s	7.3s 4.2s	63/6	63/8	69/12	72/14				
P2C	16.8s 11.7s	11.5s 6.7s	13.7s 9.7s	8.5s 4.9s	63/6	63/8	69/12	72/14				
P10	16.4s 11.6s	11.5s 6.7s	11.4 s 9.4 s	7.3s 4.2s	63/6	63/8	69/12	72/14				
P10A	18.0s 12.1s	11.5s 6.7s	15.0s 11.8s	7.3s 4.2s	63/6	63/8	69/12	72/14				
P10 C	16.8s 11.7s	11.5s 6.7s	13.7s 9.8s	8.5s 4.9s	63/6	63/8	69/12	72/14				
P12	11.9 s	4.9s			69/8	75/8	78/14	84/12				
BW1	23.0s 23.0s	8.8s 4.5s			63/6	63/8	69/12	72/14				
BW2	18.0 s	5.1 s			63/6	66/8	69/12	72/14				
TM1.1+ TM1.2	16.1+ 16.1s	6.4+ 6.4s			66/8	69/8	72/14	75/14				
TM3	18.4 s	8.1 s			63/8	66/8	69/12	72/14				
S1	19.8s	14.4 s			69/8	75/8	78/14	84/12				
S3	20.0 s	8.1 s			69/8	75/8	78/14	84/12				

Possible kV/mA combinations for preselected patient symbols 1 and 2 for index 3E selectable using the +/- buttons on the kV/mA setting

kV	60	60	60	60	60	63	63	66	69	72	75	78	81	84	90
mA	3	5	6	7	8	6	8	8	8	8	8	7	7	6	6

Possible kV/mA combinations for preselected patient symbols 3 and 4 for index 3E selectable using the +/- buttons on the kV/mA setting





kV	60	60	60	60	60	63	63	69	69	72	75	78	81	84	90
mA	8	10	12	14	15	14	15	12	15	14	14	14	12	12	12





8.1.4 Volume exposure





The radiation exposure is expressed as an area dose product [mGycm²].





To offset measurement errors and system and unit variations, a tolerance of 20% must be expected.





The Orthophos S X-ray system operates at a fixed setting of 85 kV and values ranging from 4 to 13 mA for volume exposures.





Program: VOL1 SD				
kV/mA	85/7	85/7	85/10	85/13
Maximum effective radiation time	2.6 s	4.4 s	4.4 s	4.4 s
Dose area product (mGycm ²) with whole volume dia. 8 cm x 8 cm	203	338	479	617
Area dose product (mGycm ²) with collimation to dia. 8 cm x 5.5 cm	142	236	334	429





Program: VOL1 HD				
kV/mA	85/4	85/5	85/6	85/7
Maximum effective radiation time	14.4 s	14.4 s	14.4 s	14.4 s
Dose area product (mGycm ²) with whole volume dia. 8 cm x 8 cm	620	781	931	1088
Area dose product (mGycm ²) with collimation to dia. 8 cm x 5.5 cm	431	543	648	757





Program: VOL1 Low				
kV/mA	85/6	85/7	85/10	85/13
Maximum effective radiation time	2.2 s	2.2 s	2.2 s	2.2 s
Dose area product (mGycm ²) with whole volume dia. 8 cm x 8 cm	41	48	67	86
Area dose product (mGycm ²) with collimation to dia. 8 cm x 5.5 cm	28	33	47	60





Program: VOL2 SD				
kV/mA	85/7	85/7	85/10	85/13
Maximum effective radiation time	2.6 s	4.4 s	4.4 s	4.4 s
Dose area product (mGycm ²) with whole volume dia. 5 cm x 5.5 cm	91	151	214	275

Program: VOL2 HD				
kV/mA	85/4	85/5	85/6	85/7
Maximum effective radiation time	14.4 s	14.4 s	14.4 s	14.4 s
Dose area product (mGycm ²) with whole volume dia. 5 cm x 5.5 cm	277	348	415	485

Program: VOL2 Low				
kV/mA	85/6	85/7	85/10	85/13
Maximum effective radiation time	2.2 s	2.2 s	2.2 s	2.2 s
Dose area product (mGycm ²) with whole volume dia. 5 cm x 5.5 cm	18	21	30	38

Program: VOL3 SD				
kV/mA	85/7	85/7	85/10	85/13
Maximum effective radiation time	2.6 s	4.4 s	4.4 s	4.4 s
Area dose product (mGycm ²) with whole volume dia. 11 cm x 10 cm	331	551	781	1005
Area dose product (mGycm ²) with collimation to Ø 11 cm x upper jaw 7.5 cm / lower jaw 8 cm	254	422	598	769

Program: VOL3 HD				
kV/mA	85/4	85/5	85/6	85/7
Maximum effective radiation time	14.4 s	14.4 s	14.4 s	14.4 s
Area dose product (mGycm ²) with whole volume dia. 11 cm x 10 cm	1009	1271	1515	1771
Area dose product (mGycm ²) with collimation to Ø 11 cm x upper jaw 7.5 cm / lower jaw 8 cm	773	973	1160	1356





Program: VOL3 Low				
kV/mA	85/6	85/7	85/10	85/13
Maximum effective radiation time	2.2 s	2.2 s	2.2 s	2.2 s
Area dose product (mGycm ²) with whole volume dia. 11 cm x 10 cm	67	77	109	140
Area dose product (mGycm ²) with collimation to Ø 11 cm x upper jaw 7.5 cm / lower jaw 8 cm	51	59	83	107

Possible kV/mA combinations for the 3D exposures selectable in HD exposure mode using the +/- buttons on the kV/mA setting





kV	85	85	85	85	85	85	85
mA	4	5	6	7	8	10	12

8.1.4.1 Effective dosing by region, volume area on the object/field of view and setting





Program: VOL1 Low (8x8 cm, 8x5.5 cm maxillary/mandibular), details on the effective dose in μSv

Region	Setting				
		85 kV / 6 mA	85 kV / 7 mA	85 kV / 10 mA	85 kV / 13 mA
Anterior tooth	Full	7 μSv	8 μSv	11 μSv	15 μSv
	Maxillary	4 μSv	5 μSv	7 μSv	9 μSv
	Mandibular	5 μSv	6 μSv	9 μSv	11 μSv





Program: VOL1 SD (8x8 cm, 8x5.5 cm maxillary/mandibular), details on the effective dose in μSv

Region	Setting				
		85 kV / 7 mA	85 kV / 7 mA	85 kV / 10 mA	85 kV / 13 mA
Anterior tooth	Full	35 μSv	55 μSv	79 μSv	102 μSv
	Maxillary	26 μSv	40 μSv	57 μSv	74 μSv
	Mandibular	26 μSv	41 μSv	59 μSv	76 μSv
Molar	Full	37 μSv	57 μSv	81 μSv	105 μSv
	Maxillary	26 μSv	40 μSv	58 μSv	75 μSv
	Mandibular	28 μSv	44 μSv	64 μSv	83 μSv
Temporomandibular joint	Full	19 μSv	30 μSv	43 μSv	56 μSv
	Maxillary	6 μSv	10 μSv	15 μSv	19 μSv





Program: VOL1 HD (8x8 cm, 8x5.5 cm maxillary/mandibular), details on the effective dose in μSv

Region	Setting				
		85 kV / 4 mA	85 kV / 5 mA	85 kV / 6 mA	85 kV / 7 mA
Anterior tooth	Full	109 μSv	136 μSv	163 μSv	191 μSv
	Maxillary	78 μSv	98 μSv	117 μSv	137 μSv
	Mandibular	81 μSv	101 μSv	121 μSv	142 μSv
Molar	Full	112 μSv	140 μSv	168 μSv	196 μSv
	Maxillary	80 μSv	100 μSv	119 μSv	139 μSv
	Mandibular	88 μSv	110 μSv	132 μSv	154 μSv
Temporomandibular joint	Full	60 μSv	75 μSv	90 μSv	105 μSv
	Maxillary	20 μSv	25 μSv	30 μSv	36 μSv





**Program: VOL2 Low (5x5.5 cm maxillary/mandibular),
details on the effective dose in μSv**

Region	Setting				
		85 kV / 6 mA	85 kV / 7 mA	85 kV / 10 mA	85 kV / 13 mA
Anterior tooth	Maxillary	3 μSv	3 μSv	4 μSv	6 μSv
	Mandibular	3 μSv	3 μSv	4 μSv	6 μSv
Premolar	Maxillary	3 μSv	3 μSv	4 μSv	6 μSv
	Mandibular	3 μSv	3 μSv	4 μSv	6 μSv
Molar	Maxillary	3 μSv	4 μSv	6 μSv	7 μSv
	Mandibular	3 μSv	4 μSv	6 μSv	7 μSv





**Program: VOL2 SD (5x5.5 cm maxillary / mandibular),
details of the effective dose in μSv**

Region	Setting				
		85 kV / 7 mA	85 kV / 7 mA	85 kV / 10 mA	85 kV / 13 mA
Anterior tooth	Maxillary	15 μSv	23 μSv	33 μSv	43 μSv
	Mandibular	15 μSv	24 μSv	34 μSv	45 μSv
Premolar	Maxillary	15 μSv	23 μSv	33 μSv	43 μSv
	Mandibular	15 μSv	24 μSv	34 μSv	45 μSv
Molar	Maxillary	17 μSv	27 μSv	39 μSv	50 μSv
	Mandibular	18 μSv	28 μSv	40 μSv	52 μSv





**Program: VOL2 HD (5x5.5 cm maxillary / mandibular),
details of the effective dose in μSv**

Region	Setting				
		85 kV / 4 mA	85 kV / 5 mA	85 kV / 6 mA	85 kV / 7 mA
Anterior tooth	Maxillary	46 μSv	57 μSv	68 μSv	79 μSv
	Mandibular	48 μSv	60 μSv	71 μSv	83 μSv
Premolar	Maxillary	46 μSv	57 μSv	69 μSv	80 μSv
	Mandibular	47 μSv	59 μSv	71 μSv	83 μSv
Molar	Maxillary	54 μSv	67 μSv	80 μSv	93 μSv
	Mandibular	55 μSv	69 μSv	82 μSv	96 μSv





**Program: VOL3 Low (11x10 cm full),
details of the effective dose in μSv**

Region	Setting	 85 kV / 6 mA	 85 kV / 7 mA	 85 kV / 10 mA	 85 kV / 13 mA
Molar without anterior teeth	Full	9 μSv	11 μSv	16 μSv	20 μSv

Program: VOL3 SD (11x10 cm full, 11x7.5 cm maxillary / 11x8 cm mandibular), details of the effective dose in μSv

Region	Setting	 85 kV / 7 mA	 85 kV / 7 mA	 85 kV / 10 mA	 85 kV / 13 mA
Anterior tooth	Full	50 μSv	78 μSv	111 μSv	145 μSv
Anterior tooth	Maxillary	36 μSv	56 μSv	79 μSv	103 μSv
Anterior tooth	Mandibular	45 μSv	70 μSv	100 μSv	129 μSv









Program: VOL3 HD (11x10 cm full, 11x7.5 cm maxillary / 11x8 cm mandibular), details of the effective dose in μSv

Region	Setting	 85 kV / 4 mA	 85 kV / 5 mA	 85 kV / 6 mA	 85 kV / 7 mA
Anterior tooth	Full	154 μSv	193 μSv	231 μSv	270 μSv
Anterior tooth	Maxillary	110 μSv	137 μSv	165 μSv	192 μSv
Anterior tooth	Mandibular	138 μSv	172 μSv	207 μSv	241 μSv

8.1.5 Cephalometric exposures

The radiation time is max. 14.9s and can be reduced by selecting the Quickshot function to 7.5 s.

Level series for cephalometric exposures

Program	Max. exposure time	Max. Quickshot exposure time	Factory setting				User-defined values – Please enter here –			
										
C1	9.1s	6.1s	80/14	80/14	84/13	90/12				
C2	9.1s	6.1s	80/14	80/14	84/13	90/12				
C3	9.4s	4.7s	73/15	73/15	77/14	84/13				
C3 F	14.9 s	7.5s	73/15	73/15	77/14	84/13				
C4	9.1s	4.6 s	64/16	64/16	64/16	64/16				

Possible kV/mA combinations for cephalometric exposure

kV	60	60	60	60	60	62	64	66	69	71	73	77	80	84	90
mA	9	10	12	14	16	16	16	16	15	15	15	14	14	13	12





8.1.6 Dose information

The dose area product for the parameter combinations proposed by Dentsply Sirona has been calculated already. The DAP value can be used without any further calculations.

8.1.6.1 Dose area product parameters for Panorama images

Dose level series index 1E (8 mA / 12/14 mA series)



Specification of dose area product (DAP / energy dose) for panorama x-ray images, temporomandibular joint images, and sinus images.

Program	Maximum effective radiation time		Factory-programmed values											
			 kV/ mA	DAP mGycm ²		 kV/ mA	DAP mGycm ²		 kV/ mA	DAP mGycm ²		 kV/ mA	DAP mGycm ²	
		Quick-shot			Quick shot			Quick shot			Quick shot			Quick shot
P1	14.1	9.0	63/6	53	34	63/8	71	45	69/12	129	82	72/14	163	104
P1 L/R	8.0	5.1	63/6	30	19	63/8	40	26	69/12	73	46	72/14	92	59
P1A	14.1	9.0	63/6	53	34	63/8	71	45	69/12	129	82	72/14	163	104
P1A L/R	8.0	5.1	63/6	30	19	63/8	40	26	69/12	73	46	72/14	92	59
P1C	14.1	10.5	63/6	53	39	63/8	71	53	69/12	129	97	72/14	163	122
P1C L/R	8.0	5.9	63/6	30	22	63/8	40	30	69/12	73	54	72/14	92	68
P2	11.5	7.3	63/6	43	27	63/8	58	37	69/12	105	67	72/14	133	84
P2 L/R	6.7	4.2	63/6	25	16	63/8	34	21	69/12	61	38	72/14	77	48
P2A	11.5	7.3	63/6	43	27	63/8	58	37	69/12	105	67	72/14	133	84
P2A L/R	6.7	4.2	63/6	25	16	63/8	34	21	69/12	61	38	72/14	77	48
P2C	11.5	8.5	63/6	43	32	63/8	58	43	69/12	105	77	72/14	133	98
P2C L/R	6.7	4.9	63/6	25	18	63/8	34	25	69/12	61	45	72/14	77	56
P10	11.5	7.3	63/6	26	17	63/8	35	22	69/12	63	40	72/14	80	51
P10 L/R	6.7	4.2	63/6	15	10	63/8	20	13	69/12	37	23	72/14	47	29
P10A	11.5	7.3	63/6	26	17	63/8	35	22	69/12	63	40	72/14	80	51
P10A L/R	6.7	4.2	63/6	15	10	63/8	20	13	69/12	37	23	72/14	47	29
P10C	11.5	8.5	63/6	26	19	63/8	35	26	69/12	63	47	72/14	80	59
P10C L/R	6.7	4.9	63/6	15	11	63/8	20	15	69/12	37	27	72/14	47	34
P12	4.9		69/8	30		75/8	35		78/14	66		84/12	64	
BW1	8.8		63/6	20		63/8	27		69/12	48		72/14	61	
BW1 L/R	4.5		63/6	10		63/8	14		69/12	25		72/14	31	
BW2	5.1		63/6	12		66/8	17		69/12	28		72/14	35	

Program	Maximum effective radiation time		Factory-programmed values											
TM1.1+ TM1.2	6.4+ 6.4		66/8	71		69/8	78		72/14	148		75/14	160	
TM3	8.1		63/8	41		66/8	45		69/12	74		72/14	93	
S1	14.4		69/8	87		75/8	10 3		78/14	193		84/12	190	
S3	8.1		69/8	49		75/8	58		78/14	109		84/12	107	





Dose level series index 2E (8 mA series)

Specification of dose area product (DAP / energy dose) for panorama x-ray images, temporomandibular joint images, and sinus images.





Program	Maximum effective radiation time		Factory-programmed values											
	Seconds		 kV/ mA	DAP mGycm ²			 kV/ mA	DAP mGycm ²			 kV/ mA	DAP mGycm ²		
		Quick shot			Quick shot			Quick shot			Quick shot			Quick shot
P1	14.1	9.0	63/6	53	34	63/8	71	45	69/8	85	55	72/8	93	60
P1 L/R	8.0	5.1	63/6	30	19	63/8	40	26	69/8	48	31	72/8	53	34
P1A	14.1	9.0	63/6	53	34	63/8	71	45	69/8	85	55	72/8	93	60
P1A L/R	8.0	5.1	63/6	30	19	63/8	40	26	69/8	48	31	72/8	53	34
P1C	14.1	10.5	63/6	53	39	63/8	71	53	69/8	85	64	72/8	93	70
P1C L/R	8.0	5.9	63/6	30	22	63/8	40	30	69/8	48	36	72/8	53	39
P2	11.5	7.3	63/6	43	27	63/8	58	37	69/8	70	44	72/8	76	48
P2 L/R	6.7	4.2	63/6	25	16	63/8	34	21	69/8	41	25	72/8	44	28
P2A	11.5	7.3	63/6	43	27	63/8	58	37	69/8	70	44	72/8	76	48
P2A L/R	6.7	4.2	63/6	25	16	63/8	34	21	69/8	41	25	72/8	44	28
P2C	11.5	8.5	63/6	43	32	63/8	58	43	69/8	70	51	72/8	76	56
P2C L/R	6.7	4.9	63/6	25	18	63/8	34	25	69/8	41	30	72/8	44	32
P10	11.5	7.3	63/6	26	17	63/8	35	22	69/8	42	27	72/8	46	29
P10 L/R	6.7	4.2	63/6	15	10	63/8	20	13	69/8	25	15	72/8	27	17
P10A	11.5	7.3	63/6	26	17	63/8	35	22	69/8	42	27	72/8	46	29
P10A L/R	6.7	4.2	63/6	15	10	63/8	20	13	69/8	25	15	72/8	27	17
P10C	11.5	8.5	63/6	26	19	63/8	35	26	69/8	42	31	72/8	46	34
P10C L/R	6.7	4.9	63/6	15	11	63/8	20	15	69/8	25	18	72/8	27	20
P12	4.9		69/8	30		75/8	35		78/7	33		84/6	32	
BW1	8.8		63/6	20		63/8	27		69/8	32		72/8	35	
BW1 L/R	4.5		63/6	10		63/8	14		69/8	16		72/8	18	
BW2	5.1		63/6	12		66/8	17		69/8	19		72/8	20	
TM1.1+ TM1.2	6.4+ 6.4		66/8	71		69/8	78		72/8	85		75/8	92	
TM3	8.1		63/8	41		66/8	45		69/8	49		72/8	54	
S1	14.4		69/8	87		75/8	103		78/7	97		84/6	95	
S3	8.1		69/8	49		75/8	58		78/7	55		84/6	53	

Dose level series index 3E (8 mA /12/14 mA series)

Specification of dose area product (DAP / energy dose) for panorama x-ray images, temporomandibular joint images, and sinus images.

Program	Maximum effective radiation time		Factory-programmed values												
			 kV/ mA	DAP mGycm ²			 kV/ mA	DAP mGycm ²			 kV/ mA	DAP mGycm ²			 kV/ mA
		Quic k- shot			Quic kshot			Quic kshot			Quic kshot			Quic k- shot	
P1	14.1	9.0	63/6	53	34	63/8	71	45	69/12	129	82	72/14	163	104	
P1 L/R	8.0	5.1	63/6	30	19	63/8	40	26	69/12	73	46	72/14	92	59	
P1A	14.1	9.0	63/6	53	34	63/8	71	45	69/12	129	82	72/14	163	104	
P1A L/R	8.0	5.1	63/6	30	19	63/8	40	26	69/12	73	46	72/14	92	59	
P1C	14.1	10.5	63/6	53	39	63/8	71	53	69/12	129	97	72/14	163	122	
P1C L/R	8.0	5.9	63/6	30	22	63/8	40	30	69/12	73	54	72/14	92	68	
P2	11.5	7.3	63/6	43	27	63/8	58	37	69/12	105	67	72/14	133	84	
P2 L/R	6.7	4.2	63/6	25	16	63/8	34	21	69/12	61	38	72/14	77	48	
P2A	11.5	7.3	63/6	43	27	63/8	58	37	69/12	105	67	72/14	133	84	
P2A L/R	6.7	4.2	63/6	25	16	63/8	34	21	69/12	61	38	72/14	77	48	
P2C	11.5	8.5	63/6	43	32	63/8	58	43	69/12	105	77	72/14	133	98	
P2C L/R	6.7	4.9	63/6	25	18	63/8	34	25	69/12	61	45	72/14	77	56	
P10	11.5	7.3	63/6	26	17	63/8	35	22	69/12	63	40	72/14	80	51	
P10 L/R	6.7	4.2	63/6	15	10	63/8	20	13	69/12	37	23	72/14	47	29	
P10A	11.5	7.3	63/6	26	17	63/8	35	22	69/12	63	40	72/14	80	51	
P10A L/R	6.7	4.2	63/6	15	10	63/8	20	13	69/12	37	23	72/14	47	29	
P10C	11.5	8.5	63/6	26	19	63/8	35	26	69/12	63	47	72/14	80	59	
P10C L/R	6.7	4.9	63/6	15	11	63/8	20	15	69/12	37	27	72/14	47	34	
P12	4.9		69/8	30		75/8	35		78/14	66		84/12	64		
BW1	8.8		63/6	20		63/8	27		69/12	48		72/14	61		
BW1 L/R	4.5		63/6	10		63/8	14		69/12	25		72/14	31		
BW2	5.1		63/6	12		66/8	17		69/12	28		72/14	35		
TM1.1+ TM1.2	6.4+ 6.4		66/8	71		69/8	78		72/14	148		75/14	160		
TM3	8.1		63/8	41		66/8	45		69/12	74		72/14	93		
S1	14.4		69/8	87		75/8	10 3		78/14	193		84/12	190		
S3	8.1		69/8	49		75/8	58		78/14	109		84/12	107		

8.1.6.2 Dose area product parameters for Ceph-images

Program	Max. exposure time		Factory-programmed values											
			 kV/ mA	DAP mGycm ²		 kV/ mA	DAP mGycm ²		 kV/ mA	DAP mGycm ²		 kV/ mA	DAP mGycm ²	
		Quic kshot			Quic k- shot			Quic k- shot			Quic k- shot			Quic k- shot
C1	9.1s	6.1 s	80/14	24	16	80/14	24	16	84/13	25	17	90/12	26	18
C2	9.1s	6.1 s	80/14	24	16	80/14	24	16	84/13	25	17	90/12	26	18
C3	9.4s	4.7s	73/15	22	11	73/15	22	11	77/14	23	12	84/13	26	13
C3 30x23	14.9s	7.5 s	73/15	35	18	73/15	35	18	77/14	37	19	84/13	40	21
C4	9.1s	4.6s	64/16	18	9	64/16	18	9	64/16	18	9	64/16	18	9

8.1.6.3 Calculate dosage

For any freely programmed parameter combinations, you must calculate the value using the kV/DAP lists; see sample calculation:

Explanation

Art. 3.3 of the X-Ray Ordinance requires that the system must include either devices that show the DAP display for the radiation exposure of the patient, or that this information can be derived e.g. from tables.

The manufacturers of dental equipment have agreed on using the same measurement method. To compensate for measuring errors as well as for system and instrument variations, a tolerance of 20 % must be taken into account.

The radiation exposure is specified as the dose area product (DAP) of the absorbed dose ($Gy \times cm^2$) per mAs for each unit as well as each selectable kV level and diaphragm.

Calculation:

The values indicated below have been calculated for the parameter combinations proposed by Dentsply Sirona. If other settings are used, with the help of kV/DFP lists, proceed as follows:

1. Select the set kV level from the table of the respective X-ray system and note down the DAP factor.
2. Multiply the DAP factor by the actually used mA (as indicated on the X-ray system).
3. Multiply the result by the actual exposure time (see Multitimer or table).

Sample calculation

X-ray with program P1 and a kV/mA parameter combination of 60 kV/10 mA

Ad 1. 60 kV has a DAP factor of 0.5693 at aperture 10

Ad 2. 10 mA displayed

Ad 3. the exposure time is 14.1 s

$$DFP = 0,5693 \frac{mGy \cdot cm^2}{mAs} \times 10 mA \times 14,1 s = 80,2713 mGy \cdot cm^2$$

2D-images

kV	DAP factor program P1/P2/P12/S1/S3/TM1/TM3 (mGy x cm ² /mAs)	DAP factor program P10/BW1/BW2 (mGy x cm ² /mAs)	DAP factor program C1-C4 (mGy x cm ² /mAs)
60	0.5693	0.3448	0.1024
62	-	-	0.1101
63	0.6308	0.3820	-
64	-	-	0.1178
66	0.6983	0.4229	0.1262
69	0.7570	0.4585	0.1387
71	-	-	0.1470
72	0.8305	0.5030	-
73	-	-	0.1556
75	0.8981	0.5439	-
77	-	-	0.1737
78	0.9679	0.5862	-
80	-	-	0.1868
81	1.0420	0.6311	-
84	1.1024	0.6677	0.2055
90	1.2360	0.7486	0.2345

3D-images

kV	3D exposure mode	DAP factor program VOL1 (mGy x cm ² /mAs)		DAP factor program VOL2 (mGy x cm ² /mAs)	DAP factor program VOL3 (mGy x cm ² /mAs)	
		8 x 8	8 x 5.5	5 x 5.5	11 x 10	11 x 7.5/8
85	SD	9.459	6.583	4.191	15.401	11.790
85	HD	11.094	7.722	4.951	18.064	13.829
85	Low Dose	3.059	2.129	1.365	4.981	3.813

9 Dismantling and disposal

IMPORTANT

Please export all test reports that require safekeeping before dismantling the device.

9.1 Dismantling and reinstallation

When dismantling and reassembling the unit, proceed according to the installation instructions for new installation in order to guarantee its functioning and stability.

The X-ray unit must be recalibrated whenever structural alterations in the area surrounding the X-ray room or new installations have been performed.

9.2 Disposal

Please observe the notices in the chapter "Important information for repacking and transport".

In accordance with Directive 2012/19/EU and national disposal regulations regarding old electrical and electronic devices, please be advised that such items must be disposed of in a special way within the European Union (EU). These regulations require the environmentally friendly recycling/disposal of old electrical and electronic devices. Such items must not be disposed of as domestic refuse. This has been expressed, among other methods, using the icon of the 'crossed out trash can' since 03.24.2006.



Disposal procedure

We feel responsible for our products from the first idea to their disposal. For this reason, we give you an option to return our old electronic and electrical devices.

If you wish to dispose of your devices, please proceed as follows:

In Germany

To initiate return of the electrical device, please send a disposal request to enretec GmbH. You have the following options here:

- Use the 'Returning an electrical device' button under the 'eom' menu item on the enretec GmbH homepage (www.enretec.de).
- Alternatively, you can also contact enretec GmbH directly.

enretec GmbH
Kanalstraße 17
16727 Velten

Phone: +49 3304 3919-500

E-Mail: eom@enretec.de

In accordance with the national disposal regulations regarding old electrical and electronic devices (ElektroG), as the manufacturer, we assume the costs for disposing of the electrical and electronic devices in question. Disassembly, transport, and packaging costs shall be borne by the owner/operator.

Prior to disassembly/disposal of the unit, it must be prepared professionally (cleaned/disinfected/sterilized).

If your unit is not permanently installed, it will be collected from the practice. If it is permanently installed, it will be picked up curbside at your address by appointment.

Abroad:

For country-specific information on disposal, contact your local dental dealers.

The X-ray tube assembly for this product contains an X-ray tube with a potential implosion hazard, a small amount of beryllium, a lead lining, and mineral oil.

The unit contains counterbalancing weights made of lead.

We reserve the right to make any alterations which may be required due to technical improvements.

© Sirona Dental Systems GmbH
D3632.201.04.01.02 03.2019

Sprache: englisch
Ä.-Nr.: 000 000

Printed in Germany

Sirona Dental Systems GmbH



Fabrikstr. 31
64625 Bensheim
Germany
www.dentsplysirona.com

Order No **66 78 598 D3632**