

# VistaPano S

EN

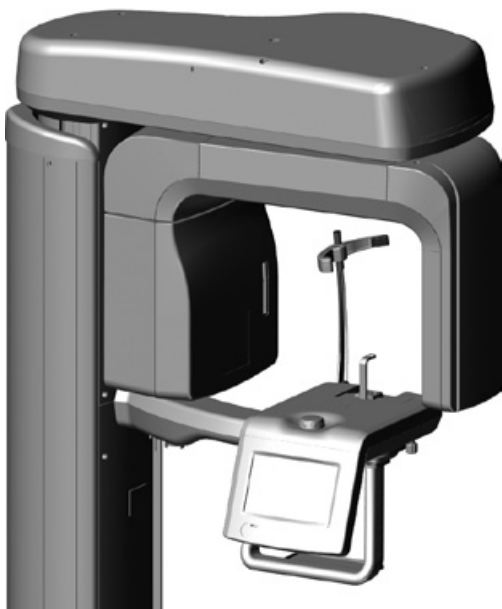

Operating Instructions

CE 2460

9000-618-256/02



 **DÜRR  
DENTAL**

1808V019



# Contents



## Important information

<b>1 About this document</b> . . . . .	3
1.1 Warnings and symbols . . . . .	3
1.2 Copyright information . . . . .	3
<b>2 Safety</b> . . . . .	4
2.1 Intended use . . . . .	4
2.2 Improper use . . . . .	4
2.3 General safety information . . . . .	4
2.4 Radiation protection . . . . .	4
2.5 Qualified personnel . . . . .	4
2.6 Electrical safety . . . . .	4
2.7 Only use original parts . . . . .	5
2.8 Transport . . . . .	5
2.9 Disposal . . . . .	5



## Product description

<b>3 Overview</b> . . . . .	6
3.1 Scope of delivery . . . . .	7
3.2 Accessories . . . . .	7
3.3 Optional accessories . . . . .	7
3.4 Consumables . . . . .	7
<b>4 Technical data</b> . . . . .	8
4.1 X-ray tube performance data . . . . .	8
4.2 Dimensions . . . . .	12
4.3 Type plate . . . . .	13
4.4 Evaluation of conformity . . . . .	13
<b>5 Operation</b> . . . . .	14
5.1 Touch screen . . . . .	14
5.2 Exposure button . . . . .	14
5.3 Positioning aids . . . . .	15
5.4 Manual switch for height adjustment (optional) . . . . .	15



## Assembly

<b>6 Requirements</b> . . . . .	16
6.1 Installation/setup room . . . . .	16
6.2 Information about electrical connections . . . . .	16
6.3 System requirements . . . . .	16

6.4 Monitor . . . . .	16
-----------------------	----

## 7 Installation . . . . . 17

7.1 Safety when making electrical connections . . . . .	17
7.2 Connecting the unit to the mains supply . . . . .	17
7.3 Combining devices safely . . . . .	17

## 8 Commissioning . . . . . 18

8.1 Acceptance test . . . . .	18
8.2 Electrical safety checks . . . . .	18
8.3 Switch on the unit . . . . .	18
8.4 Installing and configuring the unit . . . . .	18



## Usage

## 9 Operation . . . . . 20

9.1 Switch on the unit . . . . .	20
9.2 Adjusting the imaging software . . . . .	21
9.3 Inserting the positioning aid for panoramic images . . . . .	26
9.4 Inserting the positioning aid for the maxillary joint image . . . . .	26
9.5 Inserting the positioning aid for sinus images . . . . .	27
9.6 Positioning the patient . . . . .	27
9.7 Taking the X-ray . . . . .	31
9.8 Transmitting and saving the image . . . . .	33
9.9 Restoring the last image . . . . .	34
9.10 EMERGENCY OFF . . . . .	34
9.11 RETURN run . . . . .	34

## 10 Cleaning and disinfection . . . . . 35

10.1 Unit surfaces . . . . .	35
10.2 Positioning aids . . . . .	35

## 11 Reprocessing . . . . . 36

11.1 Risk analysis and categorisation . . . . .	36
11.2 Reprocessing procedure in accordance with EN ISO 17664 . . . . .	36
11.3 General information . . . . .	37
11.4 Preparation at the operating location . . . . .	37
11.5 Manual cleaning, intermediate rinsing, disinfection, final rinse, drying . . . . .	38

- 11.6 Automatic cleaning, intermediate rinsing, disinfection, final rinse, drying . . . . . 38
- 11.7 Check for function. . . . . 38
- 11.8 Steam sterilising . . . . . 38
- 11.9 Issue clearance for the parts for sterilisation . . . . . 39
- 11.10 Storing parts for sterilisation . . . . . 39
- 12 Maintenance. . . . . 40**
  - 12.1 Recommended maintenance schedule. . . . . 40



## Troubleshooting

- 13 Tips for operators and service technicians. . . . . 42**
  - 13.1 Error messages. . . . . 42



## Appendix

- 14 Information about EMC in accordance with EN 60601-1-2. . . . . 43**
  - 14.1 General notes . . . . . 43
  - 14.2 Abbreviations . . . . . 43
  - 14.3 Guidelines and manufacturer's information . . . . . 43
  - 14.4 Calculation table . . . . . 47
- 15 Program parameters . . . . . 48**
  - 15.1 Tall, well-built patient, S-Pan . . . . . 48
  - 15.2 Average patient, S-Pan . . . . . 48
  - 15.3 Small patient, S-Pan . . . . . 49
  - 15.4 Child, S-Pan . . . . . 50
  - 15.5 Child arch, tall, well-built patient . . . 50
  - 15.6 Child arch, average patient . . . . . 51
  - 15.7 Child arch, small patient . . . . . 52
- 16 Information on scattered radiation. . . . . 53**
- 17 Information on the leakage rate . . . . . 54**



# Important information

## 1 About this document

These installation and operating instructions represent part of the unit.



 If the instructions and information in these installation and operating instructions are not followed, Dürr Dental will not be able to offer any warranty or assume any liability for the safe operation and the safe functioning of the unit.

### 1.1 Warnings and symbols

#### Warnings

The warnings in this document are intended to draw your attention to possible risks of personal injury or material damage.

The following warning symbols are used:

-  General warning symbol
-  Warning – dangerous high voltage
-  Warning – X-rays

The warnings are structured as follows:

 **SIGNAL WORD**

**Description of the type and source of danger**

Here you will find a description of the possible consequences of ignoring the warning.

- › Follow these measures to avoid the danger.

The signal word differentiates between four levels of danger:

- **DANGER**  
Immediate danger of severe injury or death
- **WARNING**  
Possible danger of severe injury or death
- **CAUTION**  
Risk of minor injuries
- **ATTENTION**  
Risk of extensive material/property damage

#### Other symbols

These symbols are used in the document and on or in the unit:

-  Note, e.g. specific instructions regarding efficient and cost-effective use of the unit.
-  Comply with the Operating Instructions.
-  CE labelling with the number of the notified body
-  CSA classification
-  Manufacturer
-  Date of manufacture
-  Dispose of correctly in accordance with EU Directive 2012/19/EU (WEEE).
-  Application part type B
-  Do not reuse
-  **EC** **REP** Authorised EU representative
-  **Rx**<sub>only</sub> Caution: By virtue of Federal Law, the unit may only be sold to dentists or on behalf of a dentist.
-  Wear protective gloves.
-  Switch off and de-energise the unit (e.g. unplug from mains).
-  Laser class 1 product

### 1.2 Copyright information

All circuits, processes, names, software programs and units mentioned in this document are protected by copyright.

The Installation and Operating Instructions must not be copied or reprinted, neither in full nor in part, without written authorisation from Dürr Dental.

## 2 Safety

The unit has been developed and designed in such a way that dangers are effectively ruled out if used in accordance with the proper, intended use. Nevertheless, residual risks can remain. You should therefore observe the following notes.

### 2.1 Intended use

The unit is designed exclusively for taking panoramic X-ray images for the inspection and diagnosis of diseases in the oral cavity and craniofacial anatomy.

### 2.2 Improper use

Any other usage or usage beyond this scope is deemed to be improper. The manufacturer accepts no liability for damages resulting from improper use. In these cases the user/operator will bear the sole risk.

### 2.3 General safety information

The sale or prescription of this device by a medical practitioner is subject to the restrictions of the applicable Federal Acts. The device may be used only under permanent supervision of a dentist or licensed medical practitioner.

Caution: By virtue of Federal Law, the

**Rx<sub>only</sub>** unit may only be sold to dentists or on behalf of a dentist.

- › Always comply with the specifications of all guidelines, laws, and other rules and regulations applicable at the site of operation for the operation of this unit.
- › Check the function and condition of the unit prior to every use.
- › Do not convert or modify the unit.
- › Comply with the specifications of the Installation and Operating Instructions.
- › The Installation and Operating Instructions must be accessible to all operators of the unit at all times.

### 2.4 Radiation protection

- › Comply with all applicable X-ray protection rules and take all required X-ray protection measures.
- › Use the prescribed X-ray protection equipment.
- › In order to reduce the level of X-ray exposure, we recommend the use of bismuth, lead

shielding or protective aprons, especially for children and teenagers.

- › The persons operating the equipment must keep away from the X-ray unit while the exposure is being taken. The minimum distance required by law must be maintained (e.g. Germany 1.5 m, Austria 2.0 m).
- › Children and pregnant women must consult a doctor before having an X-ray taken.
- › Nobody else must be in the radiation room without X-ray protection measures apart from the patient. In exceptional circumstances another person may be present to provide assistance, but this must not be a member of the surgery staff. When the exposure is being taken, make sure that you maintain visual contact with the patient and the unit and keep talking to the patient.
- › The radiation room must be lockable to prevent entry by unauthorised persons.
- › If a fault occurs, cancel the exposure immediately by letting go of the trigger button.

### 2.5 Qualified personnel

#### Operation

Unit operating personnel must ensure safe and correct handling based on their training and knowledge.

- › Instruct or have every user instructed in handling the unit.

#### Installation and repairs

- › Installation, readjustments, alterations, upgrades and repairs must be carried out by Dürr Dental or by qualified personnel specifically approved and authorized by Dürr Dental.

### 2.6 Electrical safety

- › Comply with all the relevant electrical safety regulations when working on the unit.
- › Never touch the patient and unshielded plug connections on the device at the same time.
- › Replace any damaged cables or plugs immediately.

#### Observe the EMC rules concerning medical devices

- › Observe specific precautionary measures relating to electromagnetic compatibility (EMC) for medical devices, see "14 Information about EMC in accordance with EN 60601-1-2".

## 2.7 Only use original parts

- › Only use Dürr Dental parts or accessories and special accessories specifically approved by Dürr Dental.
- › Only use only original wear parts and replacement parts.

## 2.8 Transport

The original packaging provides optimum protection for the unit during transport.

If required, original packaging for the unit can be ordered from Dürr Dental.



Dürr Dental will not accept any responsibility or liability for damage occurring during transport due to the use of incorrect packaging, even where the unit is still under guarantee.

- › Only transport the unit in its original packaging.
- › Keep the packing materials out of the reach of children.
- › Reattach the transport locking devices.
- › Do not expose the unit to any strong vibrations or shocks.

Do not bump or pull the unit.

## 2.9 Disposal

### Unit



The unit must be disposed of properly.

Within the European Union, the unit must be disposed of in accordance with EU Directive 2012/19/EU (WEEE).

- › If you have any questions about the correct disposal of parts, please contact your dental trade supplier.

### X-ray emitter

The X-ray unit contains a tube that is potentially capable of imploding, lead cladding and mineral oil.



## 3 Overview

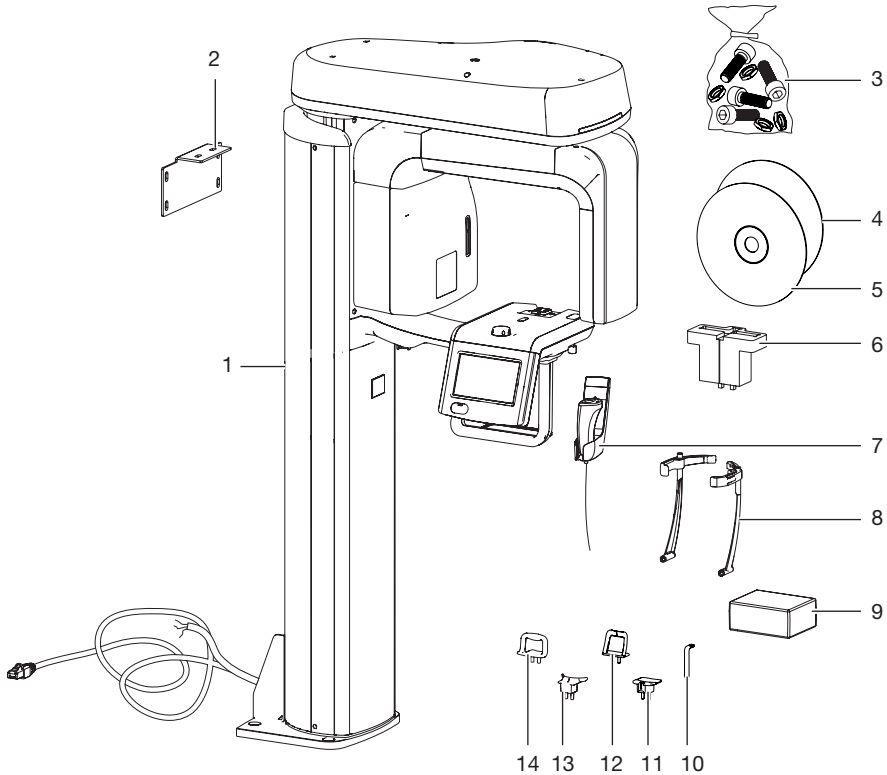

- 1 Panoramic X-ray device
- 2 Wall bracket, short
- 3 Small parts
- 4 DBSWIN imaging software DVD
- 5 VistaSoft imaging software DVD
- 6 Test body holder
- 7 Exposure switch
- 8 Head support with cushions\*
- 9 Hygienic protective covers for bite block\*
- 10 Bite block\*
- 11 Adapter for bite block\*
- 12 Chin support for maxillary joint image\*
- 13 Chin holder for edentulous jaws\*
- 14 Chin support for sinus image\*

\*These are parts that the patient will come into contact with.



### 3.1 Scope of delivery

The following items are included in the scope of delivery (possible variations due to country-specific requirements and/or import regulations):

- VistaPano S** . . . . . **2207-01**
- DBSWIN imaging software DVD
  - VistaSoft imaging software DVD
  - Network cable, 10 m
  - Exposure switch and holder
  - Adapter for bite block
  - Bite block
  - Chin holder for edentulous jaws
  - Chin holder for maxillary joint image
  - Chin holder for sinus image
  - Head support Plus with cushion
  - Hygienic protective covers for bite block (100 pieces)
  - Test body holder (Germany, Switzerland and Austria only)
  - Small parts
  - Screw cover set
  - Wall bracket set, short
  - Operating instructions
  - Installation instructions
  - PCI Express Gigabit Ethernet card

### 3.2 Accessories

The following items are required for operation of the device, depending on the application:

- Laser test tool . . . . . 2207-020-50
- Ball phantom . . . . . 2207-021-50
- Hygienic protective cover bite block (100 pieces) . . . . . 2207-010-50
- Test body holder for VistaPano S (can be used with test body set for Pano 2121-060-55 and with test body 2121-060-54) . . . . . 2207-900-50
- Adapter cable for remote exposure button . . . . . 2207-070-51
- Activation of the DBSWIN X-ray module . . . . . 2100-725-04FC

### Positioning aids

- Adapter bite block . . . . . 2207-050-50
- Bite block piece (3 pieces) . . . . . 2210200399
- Chin holder for toothless . . . . . 2207-052-50
- Head support Plus with cushion . . . . . 2210200700
- Cushion for head support Plus . . . . . 2210200701
- Chin holder for mandibular joint image . . . . . 2207-053-50
- Chin holder for sinus image . . . . . 2207-054-50

### 3.3 Optional accessories

The following optional items can be used with the device:

- Foot . . . . . 2207-100-50
- Manual switch for height adjustment incl. holder . . . . . 2207-070-50
- Screw cover set . . . . . 2207100051
- Wall bracket set, long . . . . . 2207100057

### Acceptance and consistency check

- Test body set for Pano . . . . . 2121-060-55
- Primary absorber set Pano/Ceph . . . . . 2207100047

### 3.4 Consumables

The following materials are consumed during operation of the device and must be ordered separately:

- Hygienic protective cover bite block (100 pieces) . . . . . 2207-010-50

### Cleaning and disinfection

- FD 366 rapid disinfectant for sensitive surfaces . . . . . CDF366C6150

## 4 Technical data

### Electrical data for the unit

Nominal voltage	V AC	200 - 240
Max. mains voltage fluctuation	%	±10
Frequency	Hz	50/60
Rated power	W	170
Maximum power	kVA	2.2

### Classification

Medical product class	IIb
Manufacturer: VATECH Co., Ltd. for Dürr Dental 13, Samsung 1-ro 2-gil, Hwaseong-si, Gyeonggi-do, Korea	
Authorised EU representative Vatech Dental Manufacturing Ltd., Suite 3, Ground Floor, Chancery House, St. Nicholas Way, Sutton, SM1 1JB UK	
Product	Digital X-ray system
Model	VistaPano

### X-ray emitter

Model		DG-07C11T2 (H)
Rated power	kW	1.6 (at 1 sec)
Type: high-voltage generator		Inverter
Nominal voltage, high-voltage generator	kV	50 - 99 (±10%)
Nominal current, high-voltage generator	mA	4 - 16 (for 1 kVp)
Cooling, high-voltage generator		Automatic monitoring Shut-off at ≥ 60°C
Additional filtering at 50 kV	mm Al	2.0
Integrated filtering at 50 kV	mm Al	0.8
Total filtering at 50 kV	mm Al	2.8
X-ray tube model		Toshiba D-052SB
Focal spot size as per IEC 60336 X-ray tube	mm	0.5
Anode angle	°	5
Pulse/pause ratio		1:60 or more
Duration of radiation exposure	sec.	1.9 - 13.5

### 4.1 X-ray tube performance data

- Maximum deviation of the voltage peak from the displayed value ± 10%
- Maximum deviation of the tube current from the displayed value ± 20%
- Maximum deviation of the exposure time from the displayed value ± 10%
- The device complies with the standards IEC 61223-3-4 and IEC 60601-1.
- The lowest possible stress factor is obtained with a combination of the settings 50 kV and 4 mA.

## Maximum Rating Charts

DC (Center Grounded)

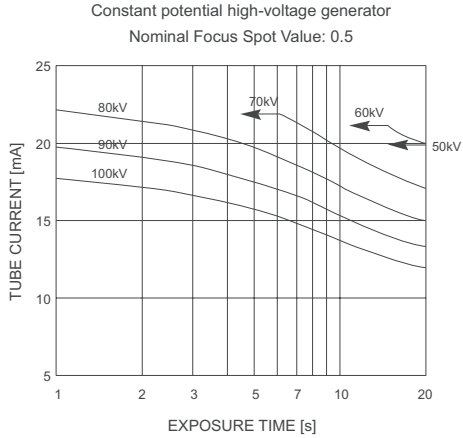

## Emission and Filament Characteristics

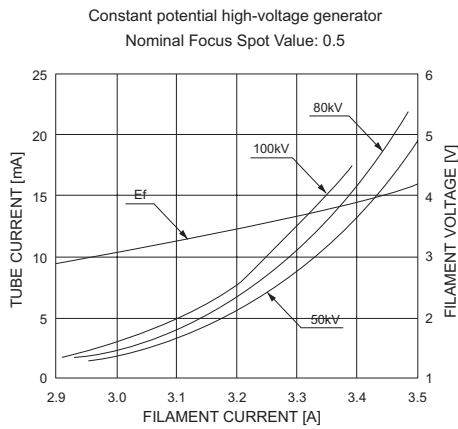

### Anode Thermal Characteristics

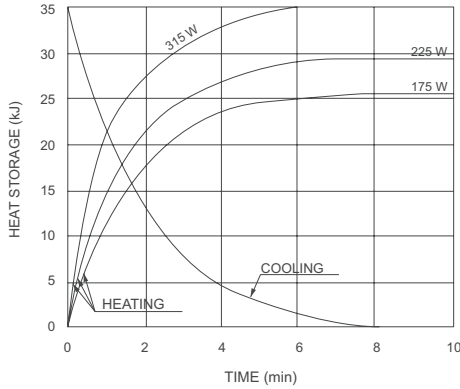

### Monoblock Cooling Curve

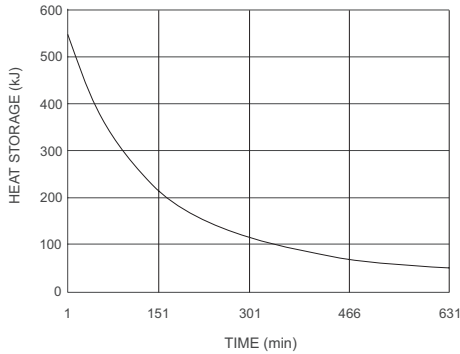

#### Detector

Brand	Xmaru 1501CF-HS	
Type	CMOS photodiode array	
Pixel size	μm	100
Active surface area	mm	6 x 150.4
Frame rate	fps	300
Greyscale	bit	14

#### General technical data

Height	mm	1580 - 2280
Dimensions (W x D)	mm	990 x 1130
Vertical radius	mm	700
Weight	kg	100
Weight with foot (optional)	kg	148

Acquisition mode	FDD mm	FOD mm	ODD mm	Image capture scale (magnification factor)
Panoramic	490.2	375.0	115.2	1.3

FDD: distance from focal spot to detector

FOD: distance from focal spot to object

ODD: distance from object to detector (ODD = FDD - FOD)

Image capture scale = FDD/FOD

Ambient conditions during operation			
Temperature	°C	10 - 35	
	°F	50 - 95	
Relative humidity	%	30 - 75	
Air pressure	hPa	860 - 1060	

Ambient conditions during storage and transport			
Temperature	°C	-10 to +60	
	°F	14 to 140	
Relative humidity	%	10 - 75	
Air pressure	hPa	860 - 1060	

## 4.2 Dimensions

EN

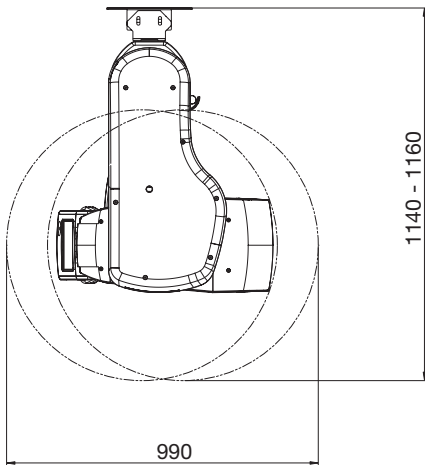
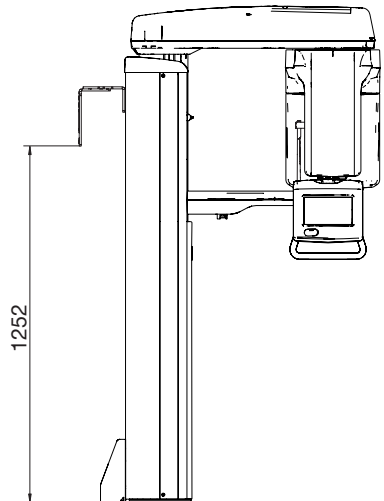
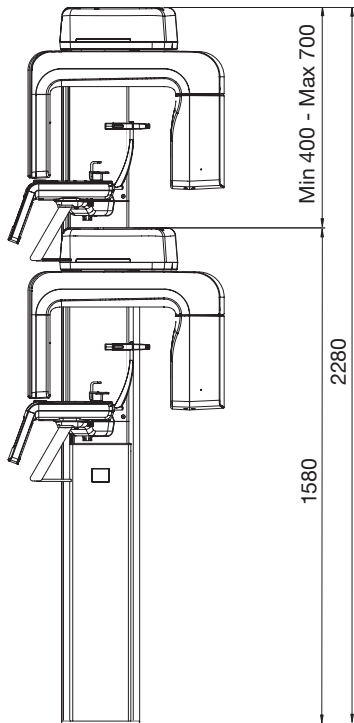

### 4.3 Type plate

The type plates are located on the X-ray emitter and on the telescopic column.

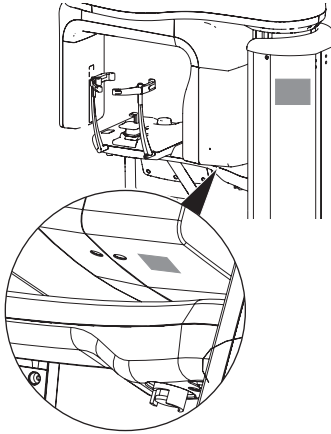

### 4.4 Evaluation of conformity

This device has been subjected to conformity acceptance testing in accordance with the current relevant European Union guidelines. This equipment conforms to all relevant requirements.

The VistaPano S has been developed and manufactured in accordance with the following regulations:

- Installation of X-ray units: [DG-10A05T3] IEC 60601-2-28 (1993)
- Protection against water penetration: Not protected: IPX0
- Protection against electric shock: Protection class I device, Type B application part

The CE mark declares that the product satisfies the applicable requirements according to Directive 93/42/EU for medical products.

## 5 Operation

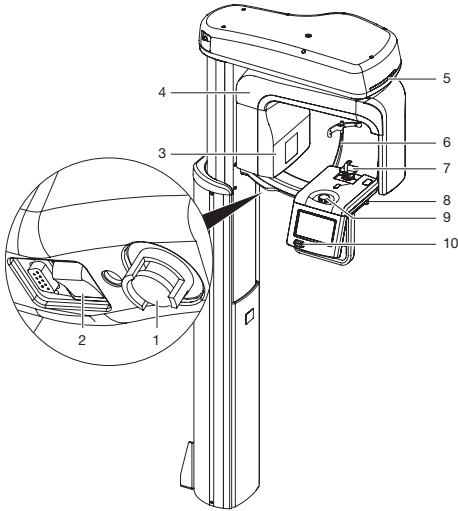

- 1 EMERGENCY OFF button
- 2 On/off switch
- 3 X-ray tube
- 4 C-shaped elbow
- 5 Status LED
- 6 Temples holders
- 7 Chin holder and bite block
- 8 Lever for adjustment of the upper canine positioning beam
- 9 Setting wheel for adjustment of the head supports
- 10 Buttons for height adjustment

The panoramic X-ray unit is used to take digital panoramic images that enable diagnostics in the oral area.

The X-ray job is started via the imaging software and activated via the touch screen.

### 5.1 Touch screen

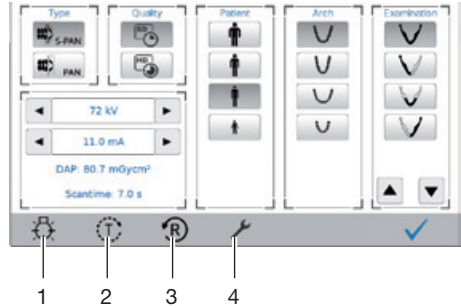

- 1 Activate/deactivate all positioning beams
- 2 Test circulation, keep the button pressed
- 3 Return
- 4 Display language

### 5.2 Exposure button

#### Exposure switch

The exposure switch is used to trigger the prepared image acquisition and start the X-ray exposure. The LED indicates the unit status, as does the LED on the unit.

- Green: The unit is ready
- Yellow: X-radiation active

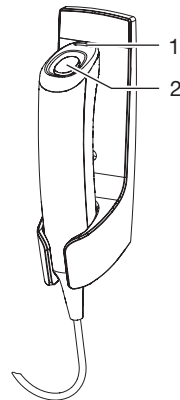

- 1 Indicator lamp (LED)
- 2 Exposure button

#### Alternative exposure button (optional)

This exposure button is usually mounted outside the X-ray room. The exposure button is used to trigger the prepared image acquisition and start the X-ray exposure.



### 5.3 Positioning aids

The positioning aids are used to correctly position the patient in the unit. The suitable positioning aid is selected according to the selected image. The head supports gently keep the head of the patient in place.

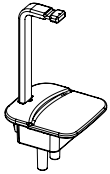

Bite block and adapter bite block

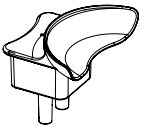

Chin holder for edentulous jaws

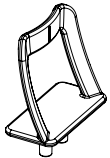

Chin holder for maxillary joint image

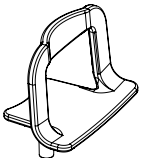

Chin holder for sinus image

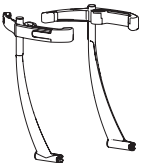

Head support with cushion

### 5.4 Manual switch for height adjustment (optional)

The manual switch can be used as an alternative to the buttons on the touch screen for the height adjustment of the unit.

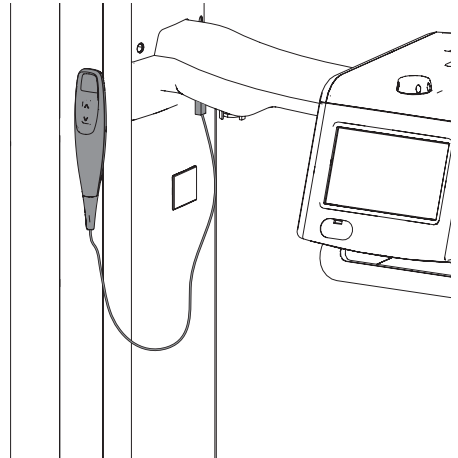

EN



Only qualified specialists or employees trained by Dürr Dental are permitted to install, connect and start using the unit.

## 6 Requirements

### 6.1 Installation/setup room

The room chosen for set up should fulfil the following requirements:

- Closed, dry room.
- Should not be a room made for another purpose (e.g. boiler room or wet cell).
- There should be no large fields of interference (e.g. strong magnetic fields) present that can interfere with the correct operation of the unit.
- The required environmental conditions are satisfied (refer to the "Technical Data" in the operating instructions).

### 6.2 Information about electrical connections

- › Ensure that the electrical connections to the mains power supply are established in accordance with current valid national and local regulations and standards governing the installation of low voltage units in medical facilities.
- › Observe the current consumption of the devices that are to be connected.

The diameter of the connections depends on the current consumption, length of line and the ambient temperature of the unit. Information concerning the current consumption can be found in the Technical Data supplied with the particular unit to be connected.

The following table lists the minimum diameters of the connections in relation to the current consumption:

Current consumption of unit [A]	Cross-section [mm <sup>2</sup> ]
> 10 and < 16	1.5
> 16 and < 25	2.5
> 25 and < 32	4
> 32 and < 40	6
> 40 and < 50	10
> 50 and < 63	16

### 6.3 System requirements



The system requirements for the computer systems can be found in the download area at [www.duerrdental.com](http://www.duerrdental.com) (document no. 9000-618-148).

### 6.4 Monitor

The monitor must comply with the requirements for digital X-ray with a high light intensity and wide contrast range.

Strong ambient light, sunlight falling directly onto the monitor and reflections can make it harder or even impossible to perform a diagnosis based on the X-ray images.

## 7 Installation

### 7.1 Safety when making electrical connections

- › Make sure that none of the electrical cables leading to the unit are under any mechanical tension.
- › Before start-up, check the mains voltage against the voltage indicated on the type plate (see also "4.3 Type plate").
- › Connect the unit and the computer to a shared protective earth.

### 7.2 Connecting the unit to the mains supply

Requirements:

- Mains voltage must match the information shown on the type plate of the power supply unit.
- › Connect up the lines.

### 7.3 Combining devices safely

Take care when connecting units together or to parts of other systems as there is always an element of risk (e.g. due to leakage currents).

- › Only connect units when there can be no question of danger to operator or to patient.
- › Only connect units when it is safe to do so and when there is no risk of damage or harm to the surroundings.
- › If it is not 100% clear from the unit data sheet that such connections can be safely made or if you are in any doubt, always get a suitably qualified person (e.g. the manufacturer) to verify that the setup is safe.
- › When connecting the unit to other devices, such as a PC system, comply with the requirements set out in section 16 of IEC 60601-1 (EN 60601-1).
- › When setting up the PC system in the vicinity of the patients:  
Only connect components (e.g. computer, monitor, printer) that comply with the standard IEC 60601-1 (EN 60601-1).
- › When setting up the PC system outside of the vicinity of the patients:  
Connect components (e.g. computer, monitor, printer) that comply at least with the standard IEC 60950-1 (EN 60950-1) at least.



A copy of the system manufacturer's declaration in accordance with Article 12 of Directive 93/42/EEC can be found in our download section at [www.duerrdent.com](http://www.duerrdent.com) (document no. 9000-461-264).

## 8 Commissioning



### NOTICE Short circuit due to the build up of condensation

- › Do not switch on the unit until it has warmed up to room temperature and it is dry.

The required tests (e.g. acceptance tests) must be carried out in accordance with local rules and regulations.

- › Find out which tests are required.
- › Carry out testing in accordance with local rules and regulations.

### 8.1 Acceptance test



The Intra/Extra Digital test body is required for performing acceptance tests for panoramic systems, together with the appropriate test body holder if necessary.

- › Before the unit is started up and used for the first time, the acceptance test of the X-ray system must be carried out in accordance with national regulations.

#### Inserting the test body holder

The test body is used on the test body holder for the acceptance test and consistency test.

- › Insert the test body holder.

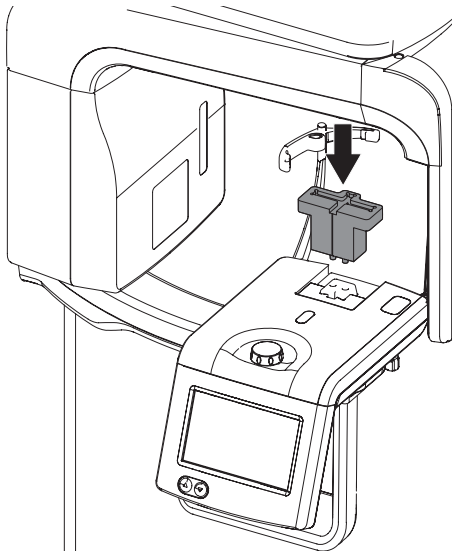

### 8.2 Electrical safety checks

- › Carry out the electrical safety check according to the national law (e. g. in accordance with IEC 62353).
- › Document the results.

### 8.3 Switch on the unit



### CAUTION Danger of injury due to movement of the the C-shaped angle connector piece

After switching on the unit and confirming the parameters on the touch screen, the C-shaped angle connector piece is positioned. Persons can be injured during this.

- › Nobody must remain in the area of the C-shaped angle connector piece while the unit is being switched on.

- › Switch on the unit.

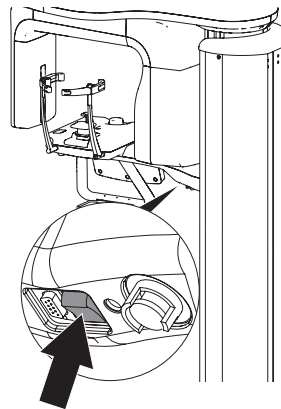

The LED on the unit flashes blue during the start-up process. Once the unit is ready for operation the LED on the unit lights up blue.

### 8.4 Installing and configuring the unit

The unit supports the following imaging programs:

- VistaSoft from Dürr Dental
- VistaConnect from Dürr Dental
- DBSWIN from Dürr Dental
- VistaEasy from Dürr Dental
- ImageBridge from Dürr Dental
- Third-party software on request

### Configuring the network

Data transmission between the unit and PC is carried out over a separate network connection. The required network cable and the Ethernet card are included in the scope of delivery of the unit.

- › Install the Ethernet card in the PC.
- › Connect the network cable with the network connection of the Ethernet card.

 The IP settings of the unit are as follows:  
 Unit IP address: 10.42.43.10  
 Subnet unit: 255.255.255.0

- › Configure the Ethernet card on the PC
  - IP address: 10.42.43.15
  - Subnet: 255.255.255.0
- › Check that Port 20130 is enabled in the Firewall of the TCP used; enable it if necessary.
- › Open the console via **Start > Run > cmd**.
- › Check the connection with the command **ping 10.42.43.10**.

### Configuring the unit

Configuration is carried out using VistaNetConfig, which is automatically installed during installation of DBSWIN or VistaEasy.

- › Select **Start > All Programs > Dürr Dental > VistaConfig > VistaNetConfig**.

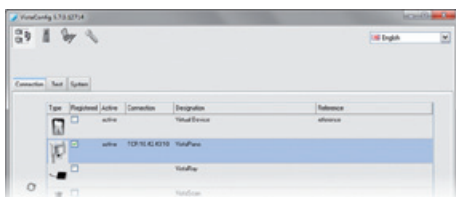

- › Click .
- The list of connected devices is updated.
- › Activate the connected device in the **Registered** column.

### Configuring the unit in VistaSoft

- › Select  > **X-ray stations > Automatic search**.
- › Select the X-ray unit from the list.
- › Enter the name and address of the operator.
- › Click **OK** to close the wizard.

The X-ray station will be displayed in the list of X-ray stations.

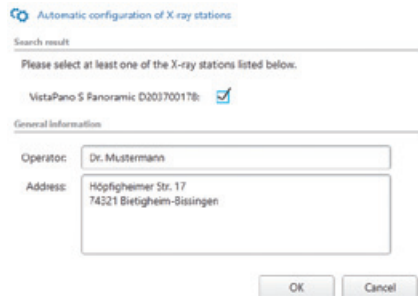

Standard image acquisition types are displayed in the menu bar.

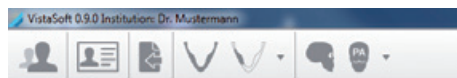

To select other acquisition types select:

- ›  > **Acquisition types**.
- › Adjust the acquisition type by clicking on Acquisition Type and selecting **Configure**.

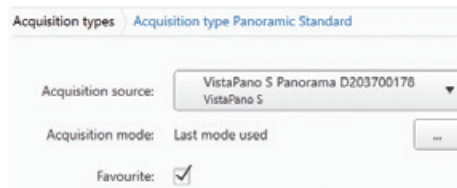

- › Click **OK** to close the wizard.
- The selected acquisition types appear additionally in the menu bar.



## 9 Operation

### 9.1 Switch on the unit



#### CAUTION

**Danger of injury due to movement of the the C-shaped angle connector piece**

After switching on the unit and confirming the parameters on the touch screen, the C-shaped angle connector piece is positioned. Persons can be injured during this.

- › Nobody must remain in the area of the C-shaped angle connector piece while the unit is being switched on.

- › Switch on the unit.

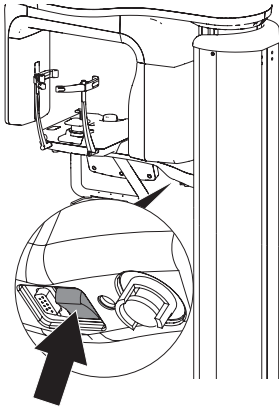

The LED on the unit flashes blue during the start-up process. Once the unit is ready for operation the LED on the unit lights up blue.

## 9.2 Adjusting the imaging software



The settings are described using the example of the DBSWIN imaging software.  
For further information on using the imaging software, refer to the relevant manual.

### Parameter overview in DBSWIN

#### Patient type

Selection of patient type will depend on the patient's size or their head circumference. This means that the preset patient type may need to be changed if necessary.

The X-ray parameters are preset using the patient type (see "Appendix").

If a child is selected then the x-ray parameters are different:

- Reduced dose
- Shorter circulation time
- Smaller radiation field



Tall, well-built patient



Average patient



Small patient



Child (< 13 years)

#### Panotype

Multiple layers are recorded with the S-PAN technology. The optimum Pano recording is produced by selecting the sharpest layer for the horizontal and vertical image areas and then merging these image areas into a single image.

S-PAN is preset.



S-PAN



PAN

#### Image quality



HD panoramic images

An improved signal/noise ratio is achieved via an extended exposure time.



SD panoramic images

This setting is used for standard images.

**Arch**

The selected jaw form influences the rotational behaviour of the C-shaped angle connector piece during image acquisition. This enables an image with an ideal layer position to be captured even on a particularly narrow or wide jaw.



Normal arch



Narrow arch



Wide arch



Child arch

**Image acquisition programs**

For panoramic images of children, the size of the radiation field is reduced with the aid of an additional collimator. The radiation dose is significantly reduced for this image.

**Panoramic images**



**Default**

The standard panoramic image records the complete dental area with ascending dental branches and maxillary joints.



**Front**

The image shows a reduced dental area without ascending dental branches.



**Right**

The image only shows the right dental area.



**Left**

The image only shows the left dental area.



**Panoramic images****Orthogonal**

The image shows the complete dental area and is generated perpendicular to the maxillary arch. This prevents overlapping crowns.

**Bite wing**

The image shows the lateral dental area with a size limited to the bite wings.

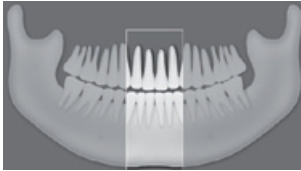
**Bite wing front**

The image shows the anterior area with a size limited to the bite wings.

**Bite wing right**

The image shows the right posterior region with a size limited to the bite wings.

**Bite wing left**

The image shows the left posterior region with a size limited to the bite wings.

**Maxillary joint imaging****Maxillary joint, lateral**

The image shows the lateral maxillary joints with an open and closed mouth in 4-fold depiction on one image.

**Maxillary joint, PA**

The image shows the posterior-anterior maxillary joints with an open and closed mouth in 4-fold depiction on one image.

**Sinus images**

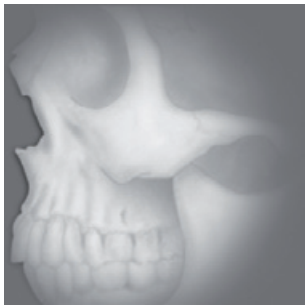

**Sinus, lateral**

The image shows the lateral sinuses.



**Sinus, PA**

The image shows the posterior-anterior sinuses.

EN

## Preparing an X-ray image in DBSWIN

- DBSWIN has been started.
- › Select the patient.
- › Select the X-ray tab.

The configuration window opens.

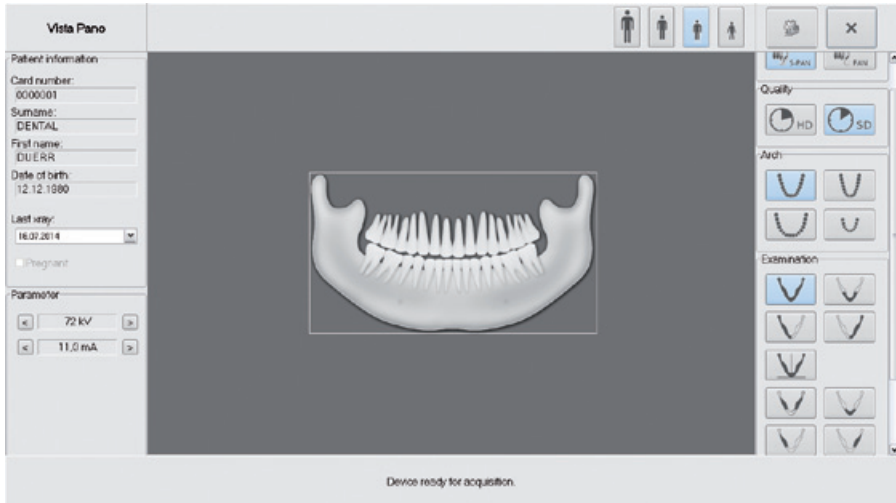

The patient type, maxillary arch and imaging program parameters are preselected according to the patient.

- › Check the parameters.
- › If the preselected parameters are correct, continue to work directly on the unit.

### 9.3 Inserting the positioning aid for panoramic images

We recommend using the mounting for the bite block and the bite block on panoramic images.

On edentulous patients the chin support for edentulous patients can be used.

The other positioning aids can be used depending on the application scenario.

**i** The bite block can be used with or without a hygienic protective cover. We recommend using the bite block with a hygienic protective cover. If the bite block is used without a hygienic protective cover, refer to the reprocessing instructions under "11 Reprocessing".



**WARNING**

**There is a danger of cross contamination if hygienic protective covers are not used or they are used more than once.**

- › Reprocess the bite block without the hygienic protective cover after use.
- › Do not use the hygienic protective cover more than once (disposable item).

- › Insert the mounting for the bite block and the bite block.

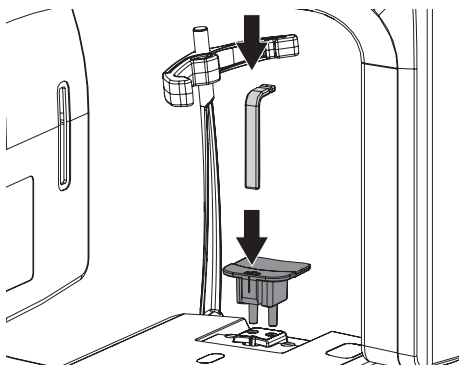

- › On edentulous patients the chin support for edentulous patients can be used.

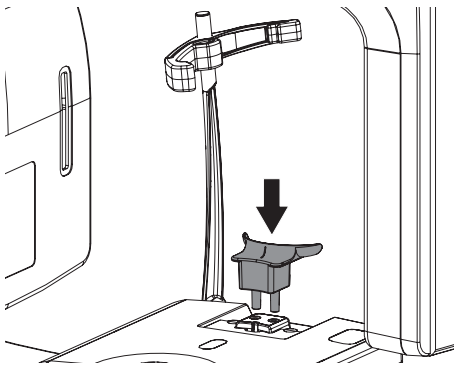

#### Inserting the positioning aid for panoramic images with hygienic protective cover (optional)



**WARNING**

**Risk of cross contamination due to non-reprocessed bite block**

- › Reprocess the bite block in accordance with the reprocessing instructions.

- › Optionally place a hygienic protective cover over the bite block.

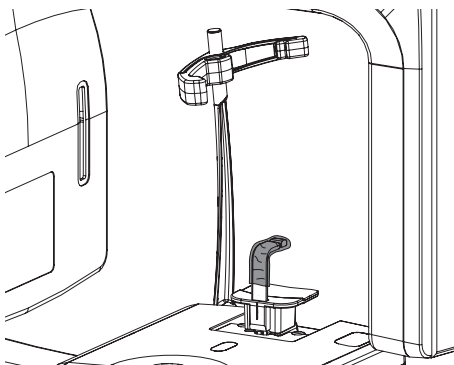

### 9.4 Inserting the positioning aid for the maxillary joint image

Correct image acquisition is only possible with the chin support for maxillary joint images.

- › Insert the chin support for the maxillary joint image.

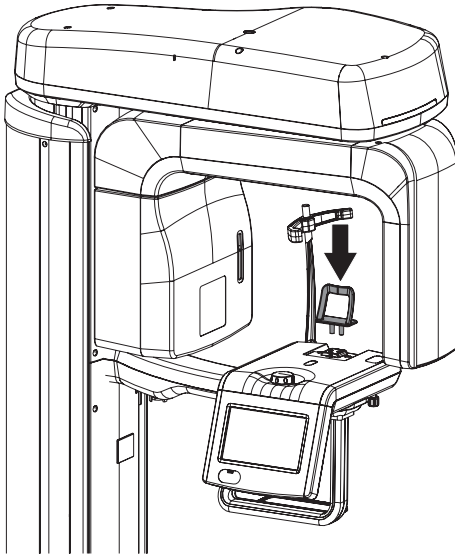

## 9.5 Inserting the positioning aid for sinus images

- › Insert the chin support for sinus images.

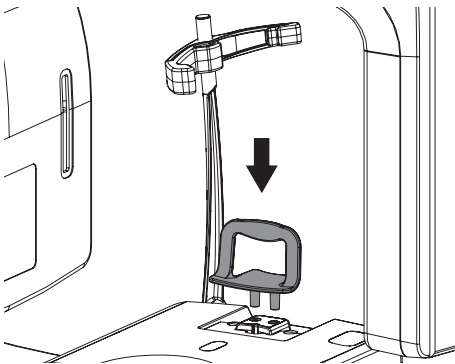

## 9.6 Positioning the patient

For the X-ray image, the patient is positioned in the unit using the corresponding positioning aids and exactly aligned using the positioning beams. The patient must not move while the image is being taken.

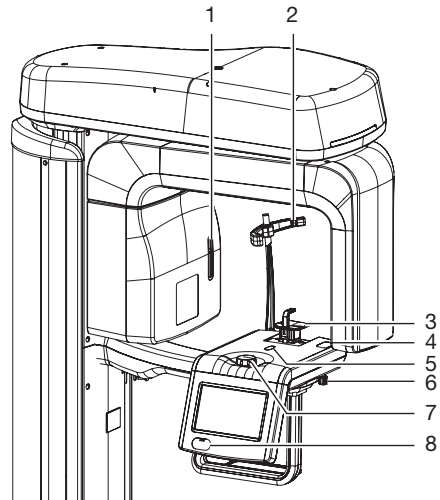

- 1 Frankfurt plane of the X-ray positioning beam
- 2 Head support with cushion
- 3 Positioning aid, e.g. adapter bite block
- 4 Upper canine positioning beam
- 5 Mid-sagittal positioning beam
- 6 Lever for positioning the upper canine positioning beam
- 7 Setting wheel for positioning the head supports
- 8 Buttons for height adjustment

### Requirements:

- The patient has taken off jewellery and metal objects, e.g. earrings, hair slides, glasses, artificial dentures or orthodontic aids.
- The patient has put on a protective lead apron.
- The patient has been informed about the X-ray procedure.
- The patient has been informed that he has to place his tongue against the roof of his mouth during the X-ray.
- The patient has been informed that he has to keep his eyes closed during positioning of the X-ray positioning beam.
- The patient has been told not to move while the X-ray is being taken until the unit is back in the starting position.



**CAUTION**

**Danger of injury due to movement of the C-shaped angle connector piece**

After switching on the unit and confirming the parameters on the touch screen, the C-shaped angle connector piece is positioned. Persons can be injured during this.

- › Nobody must remain in the area of the C-shaped angle connector piece while the unit is being switched on.

- › Bring the patient into an upright position at the unit.
- › Use the  buttons to set the height of the unit.

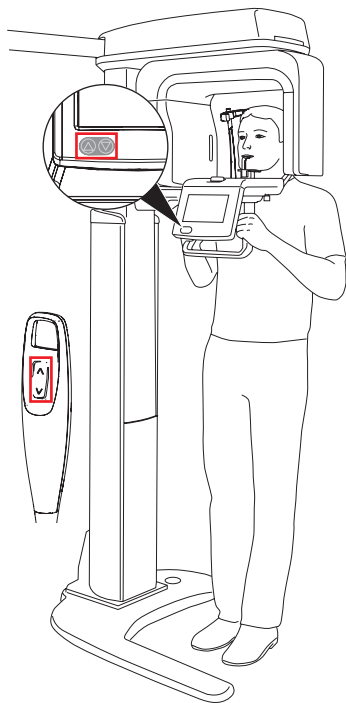

**Preparing panoramic imaging**



The bite block can be used with or without a hygienic protective cover. We recommend using the bite block with a hygienic protective cover.

If the bite block is used without a hygienic protective cover, refer to the instructions under "9.3 Inserting the positioning aid for panoramic images" and the re-processing instructions under "11 Re-processing".



**WARNING**

**There is a danger of cross contamination if hygienic protective covers are not used or they are used more than once.**

- › Reprocess the bite block without the hygienic protective cover after use.
- › Do not use the hygienic protective cover more than once (disposable item).
- › Disinfect the positioning aids, see "10 Cleaning and disinfection".
- › Place a hygienic protective cover over the bite block (optional).
- › Insert the bite block.

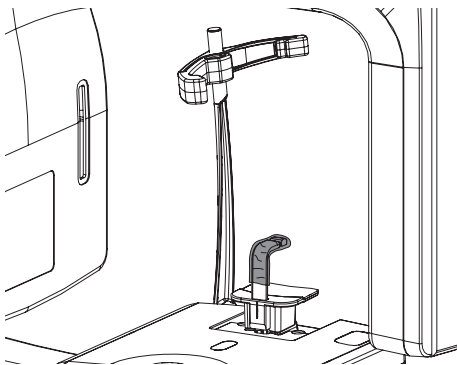

- › The patient bites onto the bite block, with the upper and lower incisors resting in the grooves provided. (Use the chin holder for

toothless in the case of patients who do not have any teeth.)

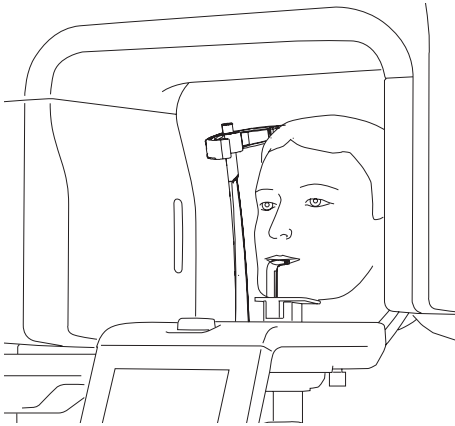

- › If necessary, correct the height of the unit again.

### Preparing the maxillary joint image



For the maxillary joint image, one image is required with the mouth closed and one with the mouth open.

- › Insert the chin support for the maxillary joint image.

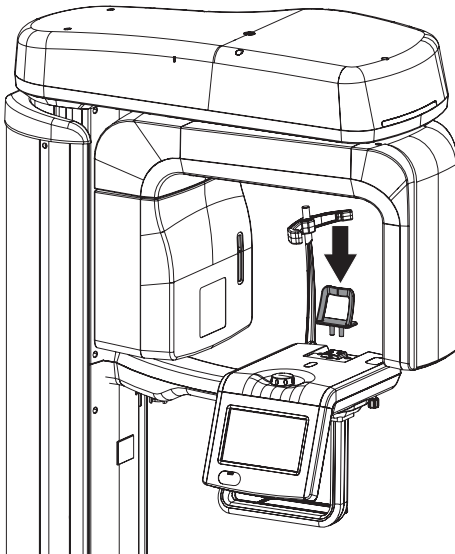

- › Position the patient with the upper lip against the chin support.

- › The patient opens or closes their mouth.

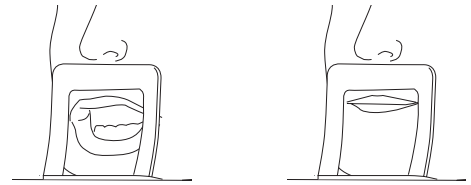

### Preparing a sinus image

- › Insert the chin support for sinus images. Insert the chin support and position the patient.

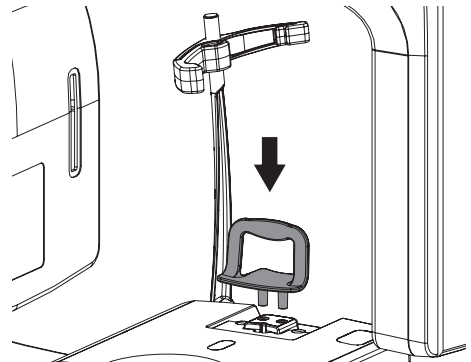

- › Position the patient so that their bottom lip presses lightly against the chin support.



## Adjusting the position with the positioning beams



### WARNING Danger – risk of dazzling from laser beam

- › Do not allow the laser beam to shine directly into the eyes of the patient.
- › Only activate the X-ray positioning beam when the patient has closed his/her eyes.



The alignment of the upper canine X-ray positioning beam is decisive for the image quality.

- › Check to make sure that the patient has closed his/her eyes.
- › If necessary, correct the height of the unit again.
- › Activate the positioning beam on the touch screen using .

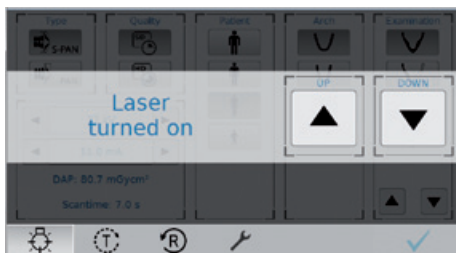

- › Align the head of the patient according to the Frankfurt horizontal plane with the aid of the X-ray positioning beam.

Exception: sinus image. Patient over-extends the cervical vertebral column to the rear by approx. 10° to 15°.

Laser height to the lower edge of the eyes.

### › For a sinus image:

Patient over-extends the cervical vertebral column by approx. 10° to 15°.

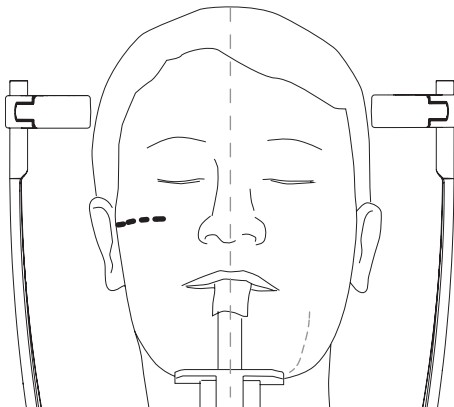

- › Check the X-ray positioning beam for the mid-sagittal plane and correct if necessary.

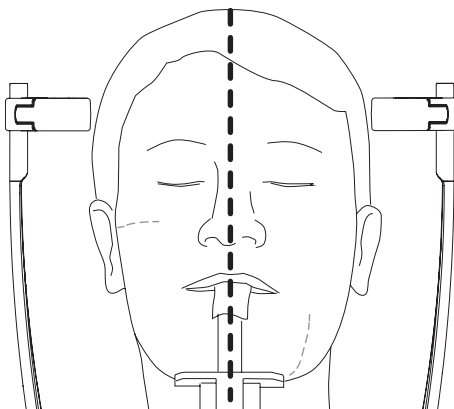

- › Have the patient smile so the upper canine is visible.

Direct the "upper canine" X-ray positioning beam as exactly as possible to the middle of the upper canine.

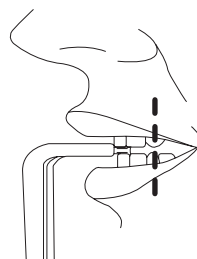



- › If necessary, correct the X-ray positioning beam manually.

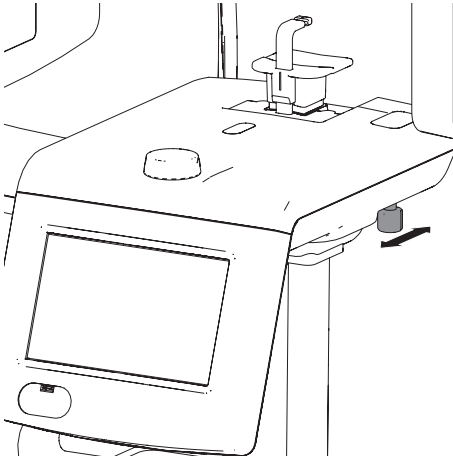

The patient is correctly positioned using the X-ray positioning beam.

- › Deactivate the X-ray positioning beam on the touch screen using .

### Adjusting the head supports

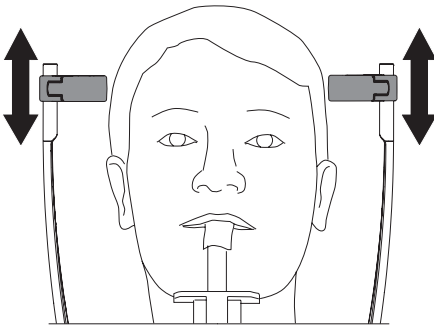

- › Adjust the height of the head supports.

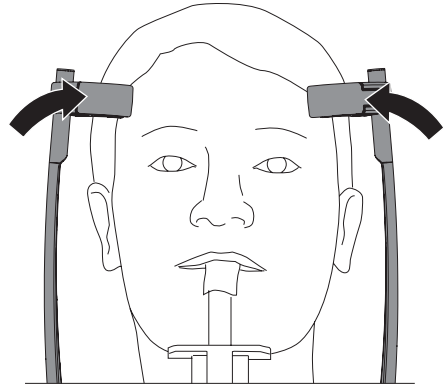

- › Carefully press the head supports by hand towards the head in order to check that they are in the right position. The device or the head supports are not damaged in the process. Ideally, the head supports should make contact slightly above the eye brows; correct the position as required.

- › Use the setting wheel to adjust the head supports so they touch the head of the patient.



- › Carry out the TEST circulation by pressing and holding the .
- › Carry out the RETURN run by pressing the .

## 9.7 Taking the X-ray



### CAUTION

#### Injuries through x-rays

X-rays can cause tissue damage.

- › Comply with the radiation protection regulations.
- › Maintain the minimum distance.



### CAUTION

#### Danger of excessively high radiation dose

- › Before an image acquisition is triggered, all data entered on the PC must be checked on the touch screen.

- › Check all parameters on the touch screen and change them if necessary. The changed parameters are immediately synchronised with DBSWIN.
- › Check that the patient has placed his/her tongue against his/her palate.
- › Activate the image using the  button.

The C-shaped arm is positioned. The LED on the exposure switch and on the unit lights up green.

The touch screen displays that the unit is ready to take an image.

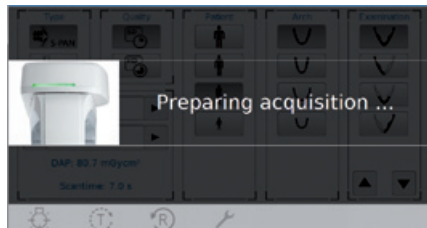

- › Trigger the image by pressing and holding the button until the acoustic signal stops and the control lamp goes out. The scanning time depends on the patient type, imaging program and image quality, see "15 Program parameters".

While the image is being taken, the LED on the exposure switch and on the unit illuminates yellow. An acoustic signal is issued.

While an X-ray is being taken, this is indicated on the touch screen with:



The C-shaped angle connector piece moves back to the starting position after the trigger button is released.

The LED on the unit lights up blue when the X-ray acquisition has been completed.

- › Release the head support.  
The patient can leave the X-ray room.
- › Remove the hygienic protective cover.
- › Remove and disinfect the positioning aids.

## 9.8 Transmitting and saving the image



While the image is being triggered, DBSWIN displays a preview of the image.

While the image preview is active, it is possible to select or deselect the S-PAN technology after taking the image. Without an image preview, the image is copied directly to the database of the software.

For further information on the software, refer to the "DBSWIN manual".

- › Check the image and optimise it if necessary.



- › Preselect S-PAN with the button  S-PAN if required.
- › Preselect PAN with the button  PAN if required.
- › Copy the image to DBSWIN with the  button.

## 9.9 Restoring the last image

- › If required, the last image can be restored by selecting the tool button .



## 9.10 EMERGENCY OFF

The EMERGENCY OFF button stops the unit and switches it off. It can be used if the unit is taking an X-ray even though the exposure button is no longer being pressed, or if the patient is injured or the unit is damaged.

- › Press the EMERGENCY OFF button.

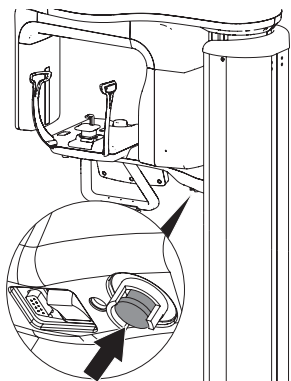

EMERGENCY OFF button lights up red.  
Device is switched off.

### Releasing the EMERGENCY OFF button

You need to release the EMERGENCY OFF button before you can restart the unit.

- › Pull the EMERGENCY OFF button down to release it.

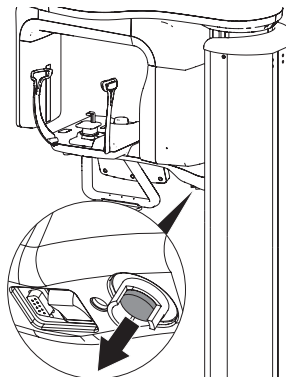

- › Switch the unit back on again.

## 9.11 RETURN run

If the X-ray acquisition has been cancelled by pressing the EMERGENCY OFF button or after a TEST cycle, the C-shaped angle connector piece will stop in its current position. The C-shaped angle connector piece needs to be moved into the starting position before you can start taking X-rays again.

- › Press the button  on the touch screen.

### Result:

The C-shaped angle connector piece moves back to the starting position.

## 10 Cleaning and disinfection



### NOTICE

**The use of unsuitable agents and methods can damage the unit and accessories.**

- › Only use the disinfectants and cleaning agents specified or approved by Dürer Dental.
- › Comply with the specifications contained in the the operating instructions of the disinfectants and cleaning agents.



Wear protective gloves.



Prior to working on the device or in case of danger, disconnect it from the mains (e. g. pull the mains plug).

### 10.1 Unit surfaces



### NOTICE

**Damage to the touch screen caused by cleaning it with disinfectant**

- › Only clean the touch screen with a soft cloth and a commercially available cleaning agent.

The unit surface must be cleaned and disinfected of any contamination or soiling. Use the following cleaning and disinfectant agents:

- FD 322 rapid surface disinfectant
- FD 333 rapid surface disinfectant
- FD 350 disinfectant wipes
- FD 366 rapid disinfectant for sensitive surfaces



### NOTICE

**Liquid can cause damage to the unit.**

- › Do not spray the unit with cleaning and disinfectant agents.
- › Make sure that liquid does not get inside the unit.

- › Remove any soiling with a soft, wet, lint-free cloth.
- › Disinfect the surfaces using a disinfection wipe. Alternatively, use a spray disinfectant on a soft, lint-free cloth. Comply with the operating instructions for the disinfectant when doing this.

## 10.2 Positioning aids

The positioning aids must be cleaned and disinfected if they are contaminated or soiled. Use the following cleaning and disinfectant agents:

- FD 322 Quick-acting surface disinfection
- FD 333 Quick-acting surface disinfection
- FD 350 Disinfection wipes
- FD 366 Quick-acting disinfectant for sensitive surfaces

### Head support with cushion

- › Pull off the head supports from the device.
- › Remove the cushions from the head supports.

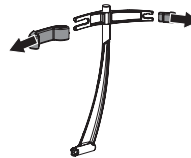

- › Removal of the cushion holder.

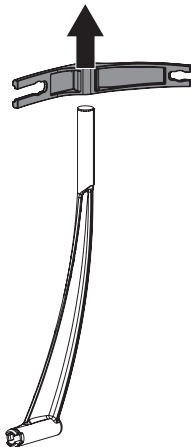

- › Remove any soiling with a soft, damp, lint-free cloth.
- › Disinfect the surfaces using a disinfection wipe. Alternatively, use a quick-acting surface disinfectant on a soft, lint-free cloth. Comply with the operating instructions for the disinfectant when doing this.

### Chin support, chin holder and bite block holder

- › Pull the chin support, chin holder or bite block holder off the device.
- › Remove any soiling with a soft, damp, lint-free cloth.

- EN
- › Disinfect the surfaces using a disinfection wipe. Alternatively, use a quick-acting surface disinfectant on a soft, lint-free cloth. Comply with the operating instructions for the disinfectant when doing this.

## 11 Reprocessing

The following accessories need to be reprocessed:

- Bite block:
  - Manual cleaning
  - Manual disinfection
  - Automatic cleaning and disinfection
  - Steam sterilisation

In order to prevent damage to the accessories, only the methods described above must be used.

### 11.1 Risk analysis and categorisation

A risk analysis and categorisation of medical products often used in dentistry must be performed before their reprocessing by the operator. Comply with all national directives, standards and specifications such as e. g. the "Recommendations from the Commission for Hospital Hygiene and Infection Prevention".

Accessories of the medical device are also subject to reprocessing.

#### Classification recommendation

Classification recommendation given proper use of the product:

##### **semi-critical A to critical A**

The operator is responsible for correct classification of the medical products, defining the reprocessing steps and performing the reprocessing.

### 11.2 Reprocessing procedure in accordance with EN ISO 17664

The reprocessing procedure after each patient treatment is carried out according to the reprocessing procedure established by EN ISO 17664.



### Important information!

The reprocessing notes in accordance with EN ISO 17664 have been independently tested by Dürr Dental for the preparation of the device and its components for their reuse.

The person conducting the reprocessing is responsible for ensuring the reprocessing performed using the equipment, materials and personnel achieves the desired results. This requires validation and routine monitoring of the reprocessing process. Any deviation from the instructions described herein by the staff preparing the equipment could lead to lower effectiveness and possible negative consequences: these lie solely with the staff responsible.

Frequent reprocessing has little effect on the device components. The end of the product life cycle is especially influenced by the amount of wear and tear or damage resulting from its use.

The use of soiled, contaminated and damaged components is at the sole responsibility of the person performing the reprocessing and the operator.

The reprocessing procedure was validated as follows:

- Pre-cleaning:
  - FD 333 Quick-acting disinfection (Dürr Dental)
- Manual cleaning:
  - ID 213 Instrument disinfection (Dürr Dental)
- Manual disinfection:
  - ID 213 Instrument disinfection (Dürr Dental)
- Automatic cleaning and disinfection:
  - Washer-disinfector: G 7836 CD (Miele, Gütersloh, Germany)
  - Cleaning agent: neodisher MediClean Dental
  - Program: *D-V-MEDICLEAN*
- Steam sterilisation:
  - Steam steriliser HST 6x6x6 (Zirbus technology GmbH, Bad Grund, Germany)

### 11.3 General information

- › Comply with all national directives, standards and specifications for the cleaning, disinfection and sterilisation of medical products as well as the specific specifications for dental practices and clinics.

- › Comply with the specifications in "11.5 Manual cleaning, intermediate rinsing, disinfection, final rinse, drying" and "11.6 Automatic cleaning, intermediate rinsing, disinfection, final rinse, drying" when selecting the cleaning and disinfectant agents to be used.
- › Comply with the concentration, temperature, residence time and post-rinsing specifications issued by the manufacturer of the cleaning and disinfectant agent.
- › Do not use any cleaning and disinfectant agents which contain chlorine, solvents, strong bases (pH >11) and oxidising agents.
- › Use non-foaming, non-fixing and aldehyde-free cleaning and disinfectant agents.
- › Do not use any rinse aid (danger of toxic residue on the components).
- › Only use freshly-produced solutions.
- › Use only distilled or de-ionised water with a low bacteria count ( $\leq$  drinking water quality).
- › Use clean, dry, oil and particle-free compressed air.
- › Do not exceed temperatures of 138 °C.
- › Subject all the devices used (ultrasonic bath, washer-disinfector, sealing device, steam steriliser) to regular maintenance and inspections.

### 11.4 Preparation at the operating location



Wear protective equipment to avoid any risk of infection (e.g. liquid-tight protective gloves, protective goggles, face mask).



#### WARNING

#### Risk of infection from contaminated products

Danger of cross contamination

- › Reprocess the product correctly and promptly before its first use and after every subsequent use.
- › Transport the device from the treatment location to the reprocessing location in such a way as to protect against contamination.
- › Remove course organic and inorganic soiling with a disinfectant cloth.

## 11.5 Manual cleaning, intermediate rinsing, disinfection, final rinse, drying

A combined cleaning and disinfectant agent is required for manual cleaning and disinfection. It must have the following properties:

- certified, possibly virucidal efficacy (DVV/RKI, VAH or European Standards)
  - without chlorine, solvents, strong alkaline solutions (pH >11) or oxidising agents
- For further information, see: "10 Cleaning and disinfection".

### Cleaning

- › Place individual parts in a cleaning agent bath making sure that all parts are covered.
- › Brush off all surfaces completely with a soft hygienic brush.
- › Note the exposure times of the cleaning agent.

### Intermediate rinsing

After the action time prescribed by the manufacturer:

- › Rinse off all components under water for at least 1 minute (temperature < 35°C).

### Disinfection

- › Place individual components in a cleaning and disinfectant bath so that all parts are covered.
- › Note the action time for the disinfectant.

### Final rinse

After the action time prescribed by the manufacturer:

- › Rinse off all components under water for at least 1 minute (temperature < 35°C).

### Drying

- › If necessary, re-dry at a clean location using a hygienic, lint-free cloth.
- › Blow dry the components with compressed air in a clean location.

## 11.6 Automatic cleaning, intermediate rinsing, disinfection, final rinse, drying

### Selection of the washer-disinfector

Automatic cleaning and disinfection requires a washer-disinfector with the following properties and validated processes:

- Corresponds to and tested in accordance with EN ISO 15883
- Certified program for thermal disinfection ( $A_0$  value  $\geq 3000$  or at least 5 minutes at 90°C)

Programme is suitable for the components and provides sufficient rinsing cycles.

For more information "11.3 General information".

### Selection of the cleaning agent automatic

The following properties are required:

- Material compatibility with the product
- Corresponds with the manufacturer's specifications of the CD

For further information, see: "11.3 General information".

### Cleaning and disinfection

- › Place all components in the cleaning and disinfection unit (follow the manufacturer's instructions).
- › Make sure there are no hidden areas that are missed by the rinsing process.
- › Secure the components with a suitable fixture of the cleaning and disinfection unit.

## 11.7 Check for function

- › After the end of the cleaning and disinfection cycle, check the components for any residual soiling and residual moisture. If necessary, repeat the cycle.
- › If necessary, replace any damaged parts.
- › The components should be packaged as soon as possible after drying and checking.

## 11.8 Steam sterilising

### Packing

For packaging of the components, only use transparent paper film sterilisation packaging that is approved for use in steam sterilisation according to the manufacturer's instructions. This includes:

- Temperature resistance up to 138°C
- Standards DIN EN ISO 11607-1/2
- The applicable sections of the standard series DIN EN 868

The sterilisation packaging must be sufficiently large. Once it is loaded, the sterilisation packaging may not be under any strain.



## Steam sterilising



### WARNING

**Incorrect sterilisation reduces effectiveness and can damage the product.**

- › Only steam sterilisation is permitted.
- › Comply with the specified process parameters.
- › Comply with the manufacturer's instructions regarding use of the steam steriliser.
- › Do not use any other methods.

### Requirements placed on the steam steriliser:

- Corresponds to EN 13060 or EN 285 and/or ANSI AAMI ST79
- Suitable programme for the products listed (e. g. with hollow bodies, fractionated vacuum procedure in three vacuum steps)
- Sufficient product drying
- Validated process in accordance with DIN EN ISO 17665 (valid IQ/OQ and product-specific performance appraisal (PQ))

Perform the following steps:

- › Sterilise the parts for sterilisation (at least 20 minutes at 121°C, at least 4 minutes at 132°C or at least 5 minutes at 134°C).



Do not exceed 138 °C.

### Marking

- › Mark the packaged, treated medical product in such a way as to ensure safe application.

## 11.9 Issue clearance for the parts for sterilisation

The reprocessing of the medical products ends with the documented clearance for storage and renewed use.

- › Document the clearance of the medical product after reprocessing.

## 11.10 Storing parts for sterilisation

- › Comply with the stated storage conditions:
  - Store the parts protected against contamination
  - Dust-protected, e.g. in a locked cabinet
  - Protected against moisture
  - Protected against excessive temperature fluctuations
  - Protected against damage

Packaging for a sterile medical device can suffer damage as a result of a particular incident and the passage of time.

Potential external contamination of the sterile barrier system should be taken into account in terms of aseptic preparation when establishing the storage conditions.

## 12 Maintenance

### 12.1 Recommended maintenance schedule

Please contact the Service department if there are discrepancies in the DAP values.

 The following must be noted when performing maintenance work.

- › The unit and the accessories required for its use must only be set up in a dry room. It must be ensured for the long term that the equipment remains in good condition.
- › The operation of the device can be influenced by factors such as temperature, light, ventilation, dust, salt etc.
- › All of the utensils required to take an X-ray should be carefully positioned to enable an effective workflow.
- › Check that the unit has an earth connection.
- › Do not fix the unit or cables yourself. This could lead to injuries or to damage to the unit.

 Prior to working on the device or in case of danger, disconnect it from the mains (e. g. pull the mains plug).

Inspection interval	Inspection work
Daily	<ul style="list-style-type: none"> <li>› Before starting up the unit, make sure that it and the positioning aids have been cleaned and disinfected (see "10 Cleaning and disinfection").</li> <li>› Is the unit switched off when no more X-ray images are to be taken?</li> <li>› Functional test of the exposure button including status LED.</li> </ul>
Weekly	<ul style="list-style-type: none"> <li>› Make sure that there is no damage to the mains cable.</li> <li>› Functional test of the EMERGENCY OFF button. Is the EMERGENCY OFF button easy to operate mechanically, and does it light up when pressed?</li> </ul>
Monthly	<ul style="list-style-type: none"> <li>› Make sure that all information signs and the type plates on the unit are undamaged and clearly legible.</li> <li>› Functional test of the speech output.</li> </ul>

 Only trained specialists or personnel trained by Dürr Dental may service the unit.

 Prior to working on the device or in case of danger, disconnect it from the mains (e. g. pull the mains plug).

Inspection interval	Inspection work
Every 3 years	<ul style="list-style-type: none"> <li>› Functional test of the display. Are all symbols displayed?</li> <li>› Functional test of the exposure button.</li> <li>› Do the various status LEDs light up?</li> <li>› Check that the head supports mechanism functions correctly. Are the head supports easy to detach and put back on?</li> <li>› Functional test of the EMERGENCY OFF button. Is the EMERGENCY OFF button easy to operate mechanically, and does it light up when pressed?</li> <li>› Light barrier test for all light barriers installed in the unit.</li> <li>› Visually check the positioning beams. Check the operation of the adjustment lever for the canine positioning beam.</li> <li>› Check the X-ray images for artifacts. If necessary, adjust the collimator and/or calibrate the sensor.</li> <li>› Check the firmware and software versions.</li> <li>› Perform a comparative dose measurement based on the requirements from the acceptance test (Germany, Switzerland and Austria only).</li> <li>› Recurring tests and tests after repairs to medical electrical equipment – DIN EN 62353 (VDE 0751-1).</li> </ul>
Maintenance interval	Maintenance work
Every 3 years	<ul style="list-style-type: none"> <li>› Visually and acoustically check the linear movement on the C-shaped angle connector piece. If necessary clean the slide rails with alcohol and grease them with Vaseline.</li> <li>› Check the operation of the lift motor. Does the unit lift and lower without any noise? If necessary, clean with alcohol and grease with Vaseline.</li> </ul>



## 13 Tips for operators and service technicians



Any repairs exceeding routine maintenance may only be carried out by qualified personnel or our service.

EN

### 13.1 Error messages

0	No connection to the unit	<ul style="list-style-type: none"> <li>› Switch the unit off and back on.</li> <li>› Inform a service technician.</li> </ul>
3	Unable to acquire an X-ray image	<ul style="list-style-type: none"> <li>› Switch the unit off and back on.</li> <li>› Inform a service technician.</li> </ul>
11	Connection between PC and unit interrupted	<ul style="list-style-type: none"> <li>› Switch the unit off and back on.</li> <li>› Inform a service technician.</li> </ul>
13	Unit is in transport mode.	<ul style="list-style-type: none"> <li>› Switch the unit off and back on.</li> <li>› Inform a service technician.</li> </ul>
37	No image was taken	<ul style="list-style-type: none"> <li>› Switch the unit off and back on.</li> <li>› Inform a service technician.</li> </ul>
230	Not enough memory space available	<ul style="list-style-type: none"> <li>› Switch the unit off and back on.</li> <li>› Inform a service technician.</li> </ul>
231	Calibration data missing	<ul style="list-style-type: none"> <li>› Switch the unit off and back on.</li> <li>› Inform a service technician.</li> </ul>

Fault	Probable cause	Solution
<b>Unit does not switch on</b>	EMERGENCY STOP SWITCH accidentally activated	› Release the EMERGENCY STOP SWITCH.
	No mains voltage	<ul style="list-style-type: none"> <li>› Check the mains cable and electrical connection; replace if necessary.</li> <li>› Inform a Service Technician.</li> <li>› Check the mains fuse in the building.</li> </ul>
	On/off switch is defective	› Inform a Service Technician.
<b>Unit not responding</b>	The unit has not yet completed the startup procedure	› After switching on, wait until the booting process has finished.
	Unit is blocked by the firewall	› Enable the ports for the unit in the firewall settings.



## 14 Information about EMC in accordance with EN 60601-1-2

### 14.1 General notes

The information in this leaflet includes excerpts from the relevant European standards for electrical, medical devices. It must be observed when installing Dürr Dental devices or combining them with products of other manufacturers. If you are uncertain about anything, please refer to the complete standard.

### 14.2 Abbreviations

EMC	Electromagnetic compatibility
HF	High frequency
$U_T$	Rated voltage of the device (supply voltage)
$V_1, V_2$	Compliance level for the test in acc. with IEC 61000-4-6
$E_1$	Compliance level for the test in acc. with IEC61000-4-3
P	Rated power of the transmitter in Watts (W) in accordance with the specifications of the transmitter manufacturer
d	Recommended safety distance in metres (m)

### 14.3 Guidelines and manufacturer's information

#### Electromagnetic emissions for all devices and systems

Interference emission measurements	Compliance	Electromagnetic environment - guidelines
HF emissions in accordance with CISPR 11	Group 1	The unit uses HF energy exclusively for internal functions. As a result, HF-transmissions are very low and it is highly unlikely that any interference will be caused to neighbouring electronic devices.
HF emissions in accordance with CISPR 11	Class A	The VistaPano S unit is suitable for use in installations other than buildings used for residential purposes and in buildings that are directly connected to the PUBLIC MAINS ELECTRICITY GRID that also supplies buildings used for residential purposes.
Harmonics in acc. with IEC 61000-3-2	Not applicable	
Voltage fluctuations/flickers in acc. with IEC 61000-3-3	Not applicable	

## Resistance to electromagnetic interference (immunity) for all devices and systems

The device is designed for use in electromagnetic environments specified below. The customer or operator of the device should ensure that the device is operated such an environment.

Interference immunity tests	IEC 60601 - test level	Compliance level	Electromagnetic environment - guidelines
Electrostatic discharge (ESD) in acc. with IEC 61000-4-2	±6 kV contact discharge ±8 kV air discharge	±6 kV contact discharge ±8 kV air discharge	Floors should be made of wood or cement, or covered with ceramic tiles. If the floor is covered by synthetic material, then the relative humidity must be at least 30%.
Electrical fast transient/burst immunity test in accordance with IEC 61000-4-4	±2 kV for mains cables ±1 kV for input and output cables	±2 kV for mains cables ±1 kV for input and output cables	The quality of the supply voltage should correspond to a typical commercial or hospital environment.
Voltage surge in accordance with IEC 61000-4-5	±1 kV voltage outer conductor/outer conductor ±2 kV voltage outer conductor/earth	±1 kV push-pull voltage ±2 kV common mode voltage	The quality of the supply voltage should correspond to a typical commercial or hospital environment.
Voltage drops, short-term interruptions and fluctuations of the supply voltage in accordance with IEC 61000-4-11	< 5% $U_T$ (> 95% drop in $U_T$ ) for 1/2 period 40% $U_T$ (60% drop in $U_T$ ) for 5 periods 70% $U_T$ (30% drop in $U_T$ ) for 25 periods < 5% $U_T$ (> 95% drop in $U_T$ ) for 5 s	< 5% $U_T$ (> 95% drop in $U_T$ ) for 1/2 period 40% $U_T$ (60% drop in $U_T$ ) for 5 periods 70% $U_T$ (30% drop in $U_T$ ) for 25 periods < 5% $U_T$ (> 95% drop in $U_T$ ) for 5 s	The quality of the supply voltage should correspond to a typical commercial or hospital environment. If the operator of the device needs the unit to continue working even if the mains power supply is interrupted, we recommend powering the device from an uninterruptible power supply (UPS) or from a battery.
Magnetic field for a supply frequency (50/60 Hz) in accordance with IEC 61000-4-8	3 A/m	3 A/m	The magnetic fields at electrical frequency should be within the range of typical values encountered in a commercial or hospital environment.

Table 1: Resistance to electromagnetic interference (immunity) for all devices and systems

**Electromagnetic interference immunity for devices or systems that are not life-sustaining**

Portable and mobile communication devices should not be used any closer to the unit (including cables) than the recommended safety distance, which is calculated based on the applicable formula for the transmission frequency.

Interference immunity tests	IEC 60601 - test level	Compliance level	Recommended safety distance
Conducted HF disturbance variables in accordance with IEC 61000-4-6	$3 V_{\text{eff}}$ 150 kHz to 80 MHz	$[V_1]$ V	$d = [3.5 / V_1] \cdot \sqrt{P}$ $d = 1.2 \cdot \sqrt{P}$
Emitted HF disturbance variables in accordance with IEC 61000-4-3	3 V/m 80 MHz to 2.5 GHz	$[E_1]$ V/m	$d = [3.5 / E_1] \cdot \sqrt{P}$ for 80 MHz to 800 MHz $d = 1.2 \cdot \sqrt{P}$ for 80 MHz to 800 MHz $d = [7 / E_1] \cdot \sqrt{P}$ for 800 MHz to 2.5 GHz $d = 2.3 \cdot \sqrt{P}$ for 800 MHz to 2.5 GHz

*Table 2: Electromagnetic interference immunity for devices or systems that are not life-sustaining*

- P Rated power of the transmitter in Watts (W) in accordance with the specifications of the transmitter manufacturer
- d Recommended safety distance in metres (m)



The field strength of stationary communication devices should be lower than the compliance level for all frequencies based on inspections on site<sup>a, b</sup>.  
Interference is possible in the environment of units that have the following symbols.

- Comment 1 The higher frequency range applies for 80 MHz and 800 MHz.
- Comment 2 These guidelines may not apply in all cases. The propagation of electromagnetic radiation is affected by absorption and reflection on the building, objects and people.

<sup>a</sup> The field strength of stationary transmitters, such as the base stations of mobile phones and land mobile radios, amateur radio stations, AM and FM radio and television broadcasters, for example, cannot be accurately predicted. In order to determine the electromagnetic environment with regard to stationary transmitters, a study of electromagnetic phenomena at the site should be considered. If the measured field strength at the location where the unit is used exceeds the compliance levels stated above, the unit should be monitored to verify that it works as intended. If unusual performance characteristics are observed additional measures may be required, such as a changing the orientation of the unit or moving it to a different location.

<sup>b</sup> Above the frequency range of 150 kHz to 80 MHz, the field strength should be less than  $[V_1]$  V/m.

### Recommended safety distance between portable and mobile HF communication devices and the unit

The device is designed for use in the electromagnetic environments specified below, in which the HF disturbance variables are controlled. The customer or the operator of the device can help to prevent electromagnetic interference by maintaining the minimum distances between mobile HF communication equipment (transmitters) and the device as recommended below in accordance with the maximum output line of the communication equipment.

Rated power of the transmitter (W)	Safety distance based on the transmission frequency (m)		
	150 kHz to 80 MHz $d = 1.2 \cdot \sqrt{P}$	80 MHz to 800 MHz $d = 1.2 \cdot \sqrt{P}$	800 MHz to 2.5 GHz $d = 2.3 \cdot \sqrt{P}$
0.01	0.12	0.12	0.23
0.1	0.38	0.38	0.73
1	1.2	1.2	2.3
10	3.8	3.8	7.3
100	12	12	23

*Table 3: Recommended safety distance between portable and mobile HF communication devices and the unit*

For transmitters whose maximum rated power is not specified in the table shown above, the recommended safety distance  $d$  in metres (m) can be determined from the formula that belongs to the respective column where  $P$  is the maximum rated power of the transmitter in Watts (W) in accordance with the specifications of the transmitter manufacturer.

Comment 1            The higher frequency range applies for 80 MHz and 800 MHz.

Comment 2            These guidelines may not apply in all cases. The propagation of electromagnetic waves is affected by absorption and reflection on the building, objects and people.



## 14.4 Calculation table

If the measured values deviate from the standard, the values are specified in chapter "4 Technical data".

The safety distances can then be calculated in the tables shown below.

P: .....

$V_1$ : .....

$E_1$ : .....

P Rated power of the transmitter in Watts (W) in accordance with the specifications of the transmitter manufacturer

$V_1$  Compliance level for the test in acc. with IEC61000-4-6

$E_1$  Compliance level for the test in acc. with IEC61000-4-3

Interference immunity tests	IEC 60601 - test level	Compliance level	Recommended safety distances
Conducted HF disturbance variables in accordance with IEC 61000-4-6	$3 V_{\text{eff}}$ 150 kHz to 80 MHz	$[V_1]$ V	$d = [3.5 / V_1] \cdot \sqrt{P}$
Emitted HF disturbance variables in accordance with IEC 61000-4-3	3 V/m 80 MHz to 2.5 GHz	$[E_1]$ V/m	$d = [3.5 / E_1] \cdot \sqrt{P}$ for 80 MHz to 800 MHz $d = [7 / E_1] \cdot \sqrt{P}$ for 800 MHz to 2.5 GHz

Rated power of the transmitter (W)	Safety distance based on the transmission frequency (m)		
	150 kHz to 80 MHz $d = [3.5/V_1] \cdot \sqrt{P}$	80 MHz to 800 MHz $d = [3.5/E_1] \cdot \sqrt{P}$	800 MHz to 2.5 GHz $d = [7 / E_1] \cdot \sqrt{P}$
0.01			
0.1			
1			
10			
100			

## 15 Program parameters

The extraoral dental X-ray system meets the requirements set out in the standard IEC 60601-2-63. The dosage information complies with the requirements of the standard and is stated in mGycm<sup>2</sup>.

### 15.1 Tall, well-built patient, S-Pan

Image quality	Program	Voltage	Current	DAP	Scanning time
		kV	mA	mGycm <sup>2</sup>	s
SD	Standard panoramic	74	15	116	7.0
SD	Right, left	74	15	57.5	3.6
SD	Front	74	15	95.3	6.0

Image quality	Program	Voltage	Current	DAP	Scanning time
		kV	mA	mGycm <sup>2</sup>	s
HD	Standard panoramic	74	10	143.0	13.5
HD	Right, left	74	10	70.9	6.7
HD	Front	74	10	117.4	11.1
HD	Bite wing	74	10	101.7	9.6
HD	Bite wing, right, left	74	10	50.8	4.8
HD	Bite wing, front	74	10	26.6	2.5
HD	Orthogonal	74	10	143	13.5
HD	Maxillary joint, lateral, open and closed	74	10	2x 64.6	6.1
HD	Maxillary joint, PA, open and closed	74	10	2x 74	7.0
HD	Sinus, lateral	74	10	63.6	6.0
HD	Sinus, PA	74	10	109.1	10.3

### 15.2 Average patient, S-Pan

Image quality	Program	Voltage	Current	DAP	Scanning time
		kV	mA	mGycm <sup>2</sup>	s
SD	Standard panoramic	73	12	90.4	7.0
SD	Right, left	73	12	44.8	3.6
SD	Front	73	12	74.3	6.0

Image quality	Program	Voltage	Current	DAP	Scanning time
		kV	mA	mGycm <sup>2</sup>	s
HD	Standard pan- oramic	73	10	139.4	13.5
HD	Right, left	73	10	69.2	6.7
HD	Front	73	10	114.5	11.1
HD	Bite wing	73	10	99.1	9.6
HD	Bite wing, right, left	73	10	49.5	4.8
HD	Bite wing, front	73	10	25.9	2.5
HD	Orthogonal	73	10	139.4	13.5
HD	Maxillary joint, lateral, open and closed	73	10	2x 62.9	6.1
HD	Maxillary joint, PA, open and closed	73	10	2x 72.2	7.0
HD	Sinus, lateral	73	10	62.0	6.0
HD	Sinus, PA	73	10	106.3	10.3

### 15.3 Small patient, S-Pan

Image quality	Program	Voltage	Current	DAP	Scanning time
		kV	mA	mGycm <sup>2</sup>	s
SD	Standard pan- oramic	72	11	80.7	7.0
SD	Right, left	72	11	40.0	3.6
SD	Front	72	11	66.2	6.0

Image quality	Program	Voltage	Current	DAP	Scanning time
		kV	mA	mGycm <sup>2</sup>	s
HD	Standard pan- oramic	72	10	135.8	13.5
HD	Right, left	72	10	67.4	6.7
HD	Front	72	10	111.5	11.1
HD	Bite wing	72	10	96.5	9.6
HD	Bite wing, right, left	72	10	48.2	4.8
HD	Bite wing, front	72	10	25.2	2.5
HD	Orthogonal	72	10	135.8	13.5
HD	Maxillary joint, lateral, open and closed	72	10	2x 61.3	6.1

Image quality	Program	Voltage	Current	DAP	Scanning time
		kV	mA	mGycm <sup>2</sup>	s
HD	Maxillary joint, PA, open and closed	72	10	2x 70.3	7.0
HD	Sinus, lateral	72	10	60.4	6.0
HD	Sinus, PA	72	10	103.6	10.3

## 15.4 Child, S-Pan

Image quality	Program	Voltage	Current	DAP	Scanning time
		kV	mA	mGycm <sup>2</sup>	s
SD	Standard panoramic	67	10	48.9	6.1
SD	Right, left	67	10	20.4	3.1
SD	Front	67	10	33.0	5.2

Image quality	Program	Voltage	Current	DAP	Scanning time
		kV	mA	mGycm <sup>2</sup>	s
HD	Standard panoramic	67	8	62.0	11.5
HD	Right, left	67	8	30.7	5.7
HD	Front	67	8	49.6	9.2
HD	Bite wing	67	8	68.9	9.6
HD	Bite wing, right, left	67	8	34.5	4.8
HD	Bite wing, front	67	8	17.9	2.5
HD	Orthogonal	67	8	62.0	11.5
HD	Maxillary joint, lateral, open and closed	67	8	2x 43.9	6.1
HD	Maxillary joint, PA, open and closed	67	8	2x 50.3	7.0
HD	Sinus, lateral	67	8	43.1	6.0
HD	Sinus, PA	67	8	74.0	10.3

## 15.5 Child arch, tall, well-built patient

Image quality	Program	Voltage	Current	DAP	Scanning time
		kV	mA	mGycm <sup>2</sup>	s
SD	Standard panoramic	74	15	87.9	6.1
SD	Right, left	74	15	36.6	3.1
SD	Front	74	15	59.2	5.2

Image quality	Program	Voltage	Current	DAP	Scanning time
		kV	mA	mGycm <sup>2</sup>	s
HD	Standard pan- oramic	74	10	91.4	11.5
HD	Right, left	74	10	45.2	5.7
HD	Front	74	10	73.0	9.2
HD	Bite wing	74	10	101.7	9.6
HD	Bite wing, right, left	74	10	50.8	4.8
HD	Bite wing, front	74	10	26.6	2.5
HD	Orthogonal	74	10	91.4	11.5
HD	Maxillary joint, lateral, open and closed	74	10	2x 64.6	6.1
HD	Maxillary joint, PA, open and closed	74	10	2x 74	7.0
HD	Sinus, lateral	74	10	63.6	6.0
HD	Sinus, PA	74	10	109.1	10.3

## 15.6 Child arch, average patient

Image quality	Program	Voltage	Current	DAP	Scanning time
		kV	mA	mGycm <sup>2</sup>	s
SD	Standard pan- oramic	73	12	68.5	6.1
SD	Right, left	73	12	28.5	3.1
SD	Front	73	12	46.2	5.2

Image quality	Program	Voltage	Current	DAP	Scanning time
		kV	mA	mGycm <sup>2</sup>	s
HD	Standard pan- oramic	73	10	89.1	11.5
HD	Right, left	73	10	44.0	5.7
HD	Front	73	10	71.1	9.2
HD	Bite wing	73	10	99.1	9.6
HD	Bite wing, right, left	73	10	49.5	4.8
HD	Bite wing, front	73	10	25.9	2.5
HD	Orthogonal	73	10	89.1	11.5
HD	Maxillary joint, lateral, open and closed	73	10	2x 62.9	6.1
HD	Maxillary joint, PA, open and closed	73	10	2x 72.2	7.0

Image quality	Program	Voltage	Current	DAP	Scanning time
		kV	mA	mGycm <sup>2</sup>	s
HD	Sinus, lateral	73	10	62.0	6.0
HD	Sinus, PA	73	10	106.3	10.3

## 15.7 Child arch, small patient

Image quality	Program	Voltage	Current	DAP	Scanning time
		kV	mA	mGycm <sup>2</sup>	s
SD	Standard panoramic	72	11	61.2	6.1
SD	Right, left	72	11	25.5	3.1
SD	Front	72	11	41.2	5.2

Image quality	Program	Voltage	Current	DAP	Scanning time
		kV	mA	mGycm <sup>2</sup>	s
HD	Standard panoramic	72	10	86.8	11.5
HD	Right, left	72	10	42.9	5.7
HD	Front	72	10	69.3	9.2
HD	Bite wing	72	10	96.5	9.6
HD	Bite wing, right, left	72	10	48.2	4.8
HD	Bite wing, front	72	10	25.2	2.5
HD	Orthogonal	72	10	86.8	11.5
HD	Maxillary joint, lateral, open and closed	72	10	2x 61.3	6.1
HD	Maxillary joint, PA, open and closed	72	10	2x 70.3	7.0
HD	Sinus, lateral	72	10	60.4	6.0
HD	Sinus, PA	72	10	103.3	10.3

## 16 Information on scattered radiation

Test equipment: Dosemeter Victoreen 660

### Test conditions

Program parameters	HD / Adult / Standard Pano
Distance to the focal spot	1 m
Voltage	80 kVp
Current	16 mA

R °	HD, 13.5 s		
	1 m	1.5 m	2 m
0	98.4 mR/h	37.8 mR/h	19.8 mR/h
45	34.7 mR/h	17.6 mR/h	9.3 mR/h
90	15.4 mR/h	6.2 mR/h	3.5 mR/h
135	14.9 mR/h	7.1 mR/h	4.5 mR/h
180	0 mR/h	0 mR/h	0 mR/h
225	37.2 mR/h	14.4 mR/h	8.9 mR/h
270	51.4 mR/h	21.5 mR/h	12.9 mR/h
315	86.1 mR/h	34.7 mR/h	18.2 mR/h

## 17 Information on the leakage rate

Test equipment: Dosimeter Victoreen 660

### Test conditions

Program parameters HD / Adult, child / Standard Pano

Distance to the focal spot 1 m

Voltage 90 kVp

Current 16 mA

Direction	HD, Adult, 13.5 s	HD, Child, 11.5 s
0	0 mR/h	1.5 mR/h
10	3.9 mR/h	3.7 mR/h
20	4 mR/h	4.5 mR/h
30	0 mR/h	4.8 mR/h
40	0 mR/h	0.9 mR/h
45	0 mR/h	10.7 mR/h
50	4.8 mR/h	15.7 mR/h
60	0 mR/h	11.1 mR/h
70	0 mR/h	7.5 mR/h
80	4.6 mR/h	6.8 mR/h
90	2.1 mR/h	14.8 mR/h
100	0 mR/h	14.5 mR/h
110	0 mR/h	14.9 mR/h
120	0 mR/h	15.3 mR/h
130	0 mR/h	15.8 mR/h
135	0 mR/h	16.5 mR/h
140	0 mR/h	14.8 mR/h
150	0 mR/h	15 mR/h
160	0 mR/h	0 mR/h
170	0 mR/h	0 mR/h
180	0 mR/h	0 mR/h
190	0 mR/h	0 mR/h
200	0 mR/h	0.7 mR/h
210	0 mR/h	0.9 mR/h
220	0 mR/h	1.8 mR/h
225	1.3 mR/h	2.1 mR/h
230	6.2 mR/h	2.4 mR/h
240	1.2 mR/h	6.6 mR/h
250	1.6 mR/h	4 mR/h
260	7.6 mR/h	6.3 mR/h
270	14.8 mR/h	13 mR/h
280	35.4 mR/h	19.6 mR/h

Direction	HD, Adult, 13.5 s	HD, Child, 11.5 s
290	19.2 mR/h	20.2 mR/h
300	8.8 mR/h	9.4 mR/h
310	7.1 mR/h	8.6 mR/h
315	6 mR/h	7.4 mR/h
320	6.3 mR/h	6.3 mR/h
330	5.1 mR/h	5.7 mR/h
340	6.3 mR/h	4.6 mR/h
350	4.5 mR/h	4 mR/h











**Hersteller/Manufacturer:**

VATECH Co. Ltd.

13, Samsung 1-ro 2-gil

Hwaseong-si, Gyeonggi-do, 18449

Korea

Fon: +82 31 323 8639

[www.vatech.co.kr](http://www.vatech.co.kr)

**Vertreiber/Distributor:**

DÜRR DENTAL SE

Höpfigheimer Str. 17

74321 Bietigheim-Bissingen

Germany

Fon: +49 7142 705-0

[www.duerrdental.com](http://www.duerrdental.com)

[info@duerrdental.com](mailto:info@duerrdental.com)

